



MY

HANDWRITING

JOURNAL

BY: _____



MY
UPPERCASE
HANDWRITING
JOURNAL

BY: _____



MY
LOWERCASE
HANDWRITING
JOURNAL

BY: _____

NAME: _____

DATE: _____



SKY DWELLERS

A B C D E F G H I

J K L M N O P Q R

S T U V W X Y Z

b d f h k l t

NAME: _____

DATE: _____



SKY DWELLERS

A B C D E F G H I

J K L M N O P Q R

S T U V W X Y Z

Blank handwriting lines for practice, consisting of a solid blue top line, a dashed green middle line, and a solid brown bottom line.

NAME: _____

DATE: _____



SKY DWELLERS

b d f h k l t

Three sets of handwriting practice lines. Each set consists of a solid blue top line, a dashed green middle line, and a solid brown bottom line.

NAME: _____

DATE: _____

GRASS GROWERS

a c e i m n o

r s u v w x z

NAME: _____

DATE: _____



ROOT DIGGERS

g j p q y

NAME: _____

DATE: _____

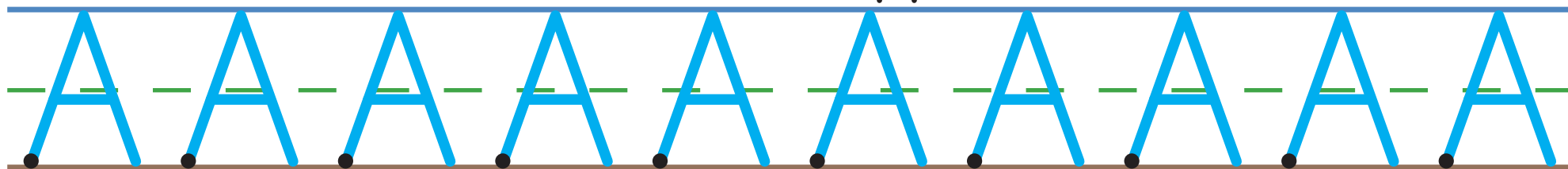
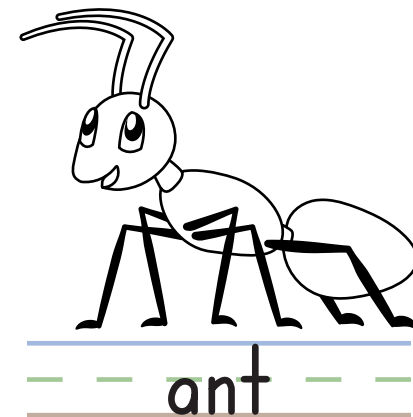
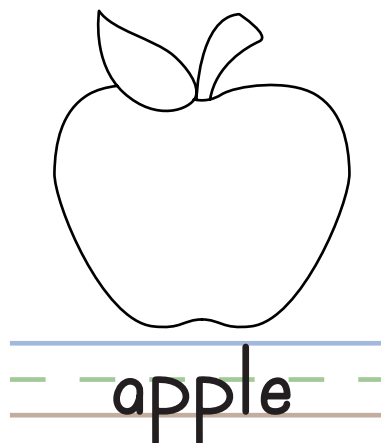
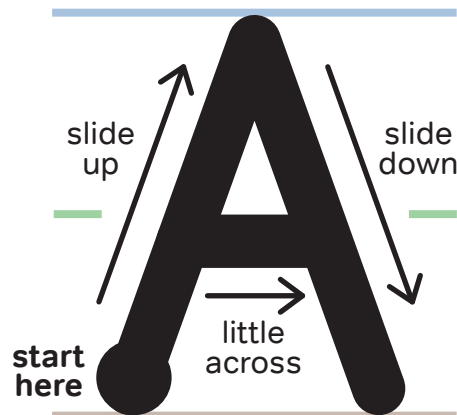

Write an uppercase letter **A** at each dot.

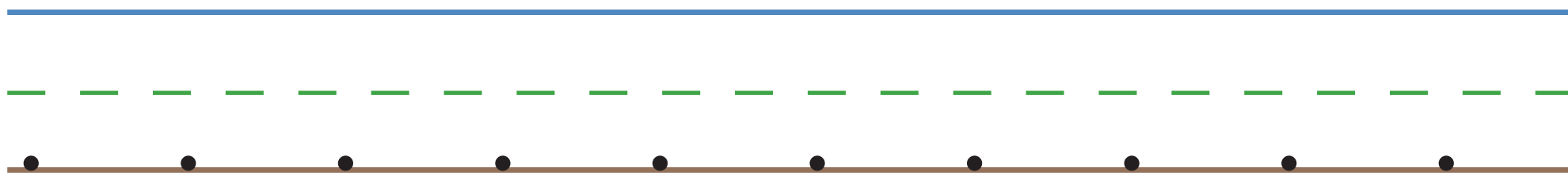

Write 10 amazing **A**'s all on your own.

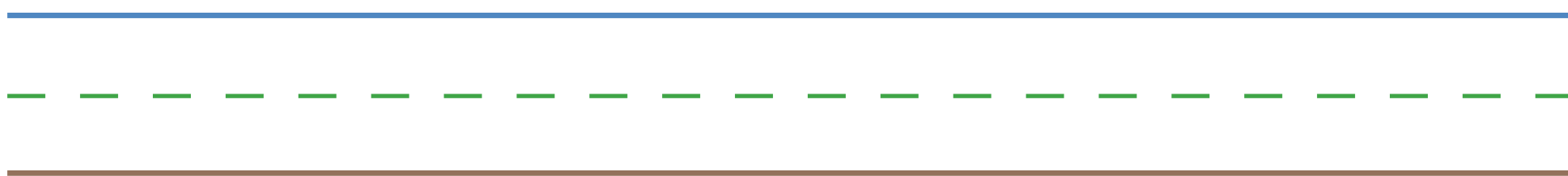

NAME: _____

DATE: _____

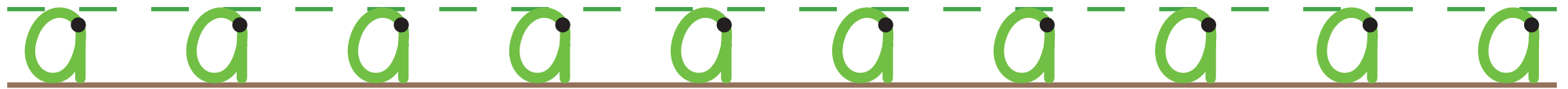
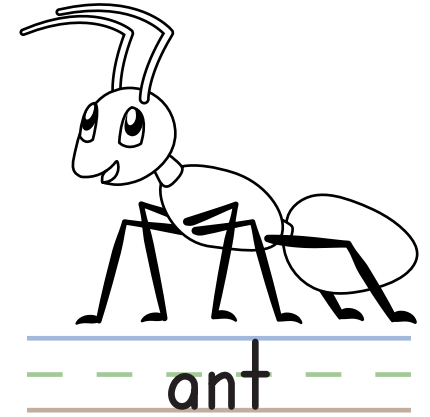
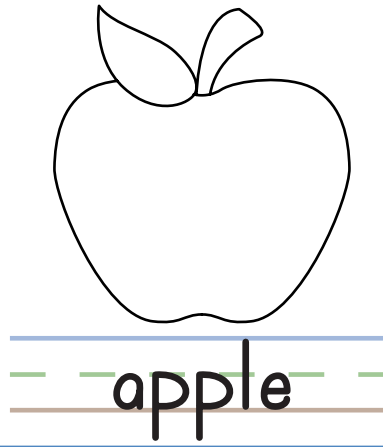
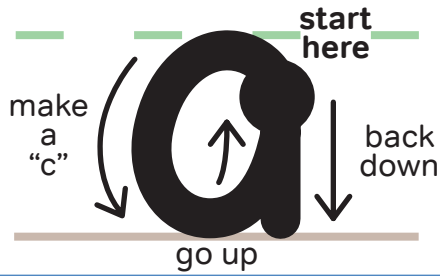

Write a lowercase letter **a** at each dot.



Write 10 amazing **a**'s all on your own.



NAME: _____

DATE: _____

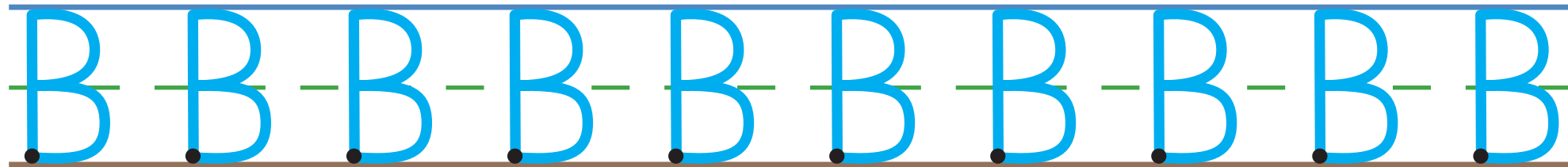
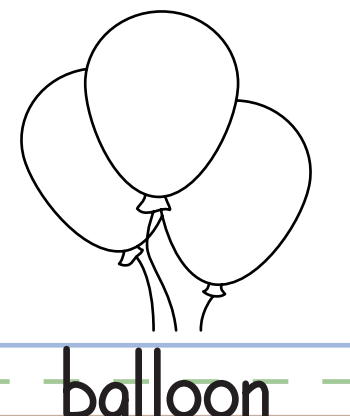
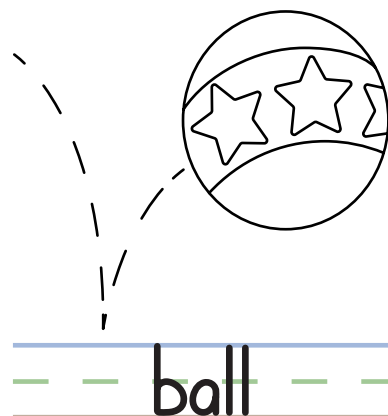
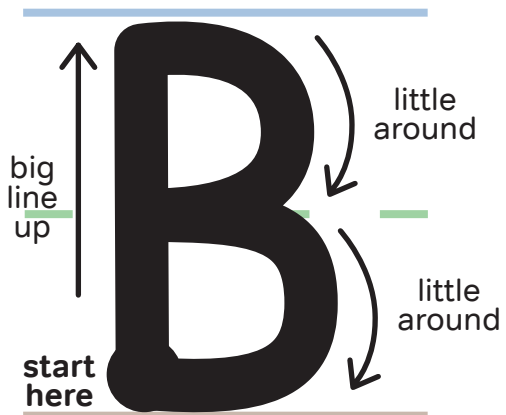

Write an uppercase letter **B** at each dot.

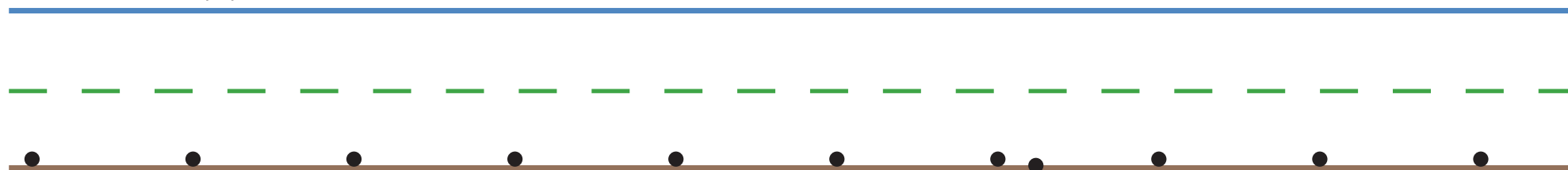

Write 10 beautiful **B**'s all on your own.



NAME: _____

DATE: _____

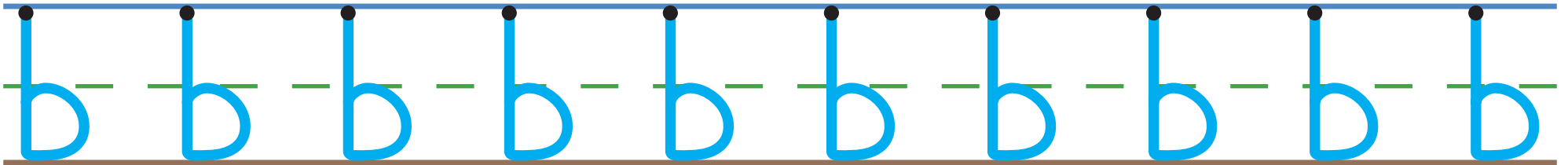
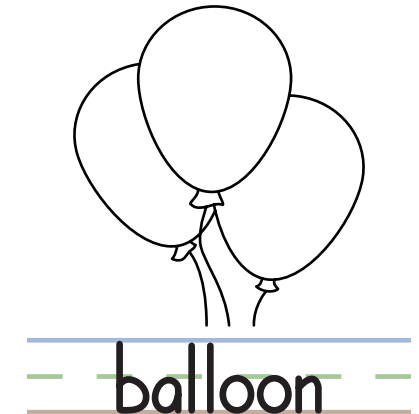
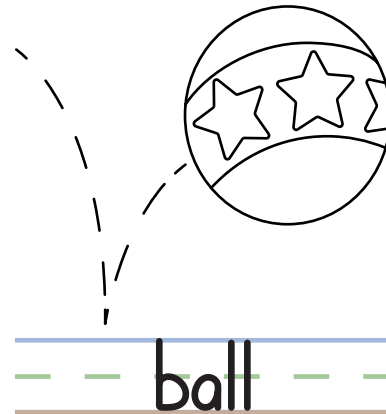
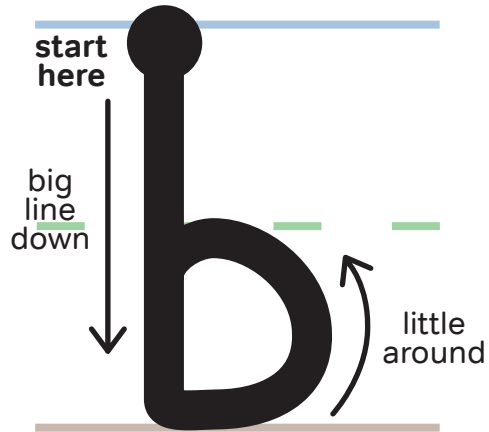

Write a lowercase letter **b** at each dot.

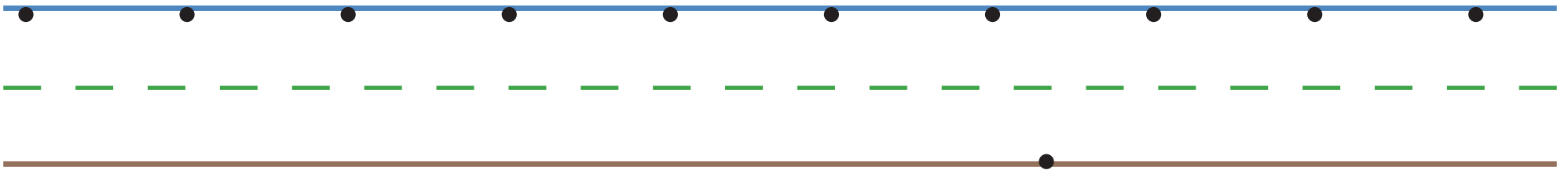

Write 10 beautiful **b**'s all on your own.

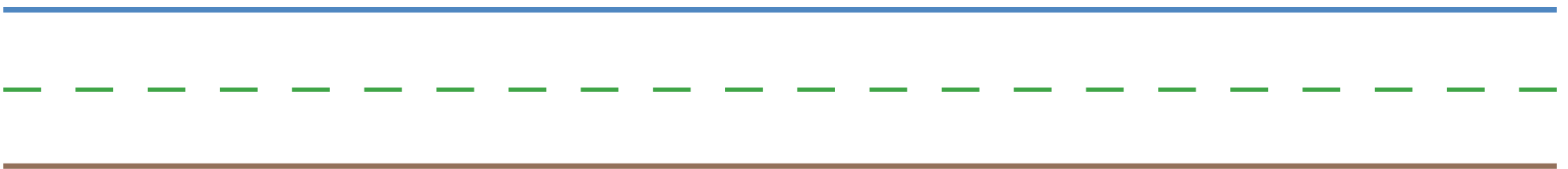

NAME: _____

DATE: _____

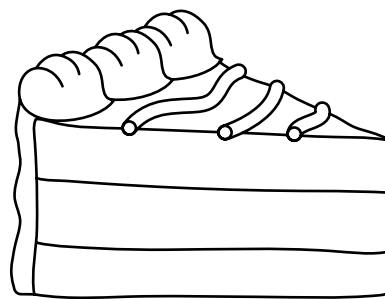
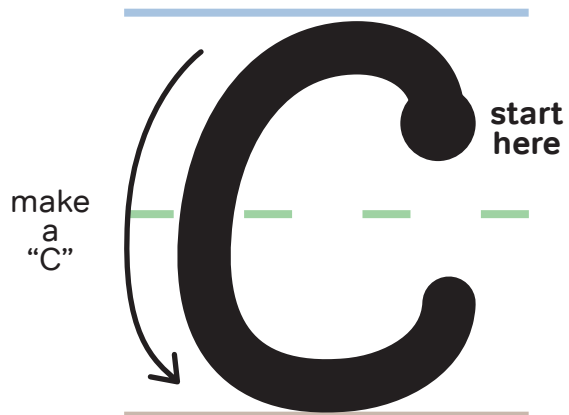

cake

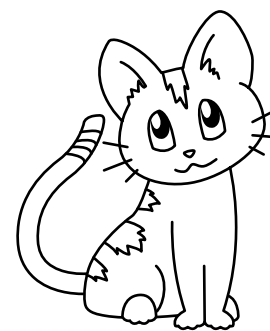

cat

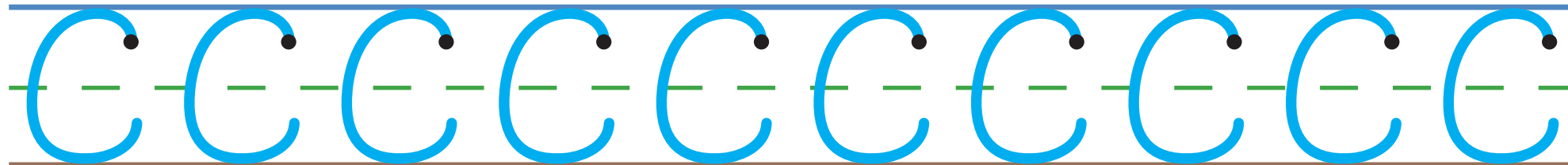

Write an uppercase letter **C** at each dot.

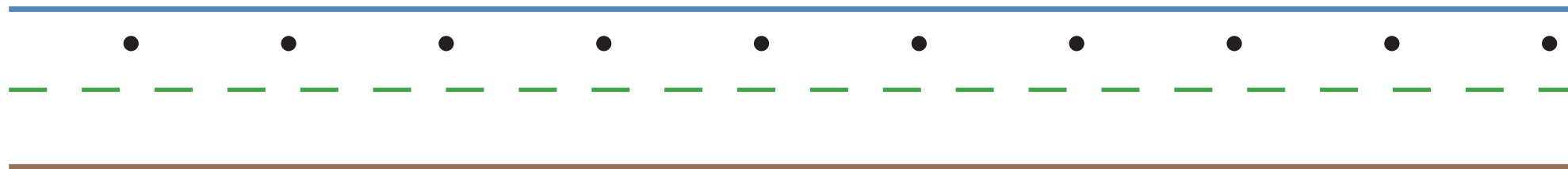

Write 10 curvy **C**'s all on your own.



NAME: _____

DATE: _____

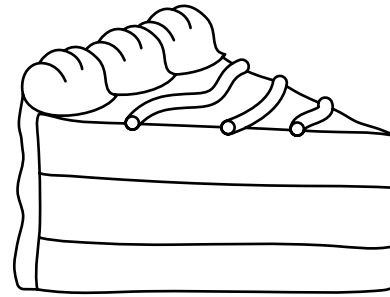
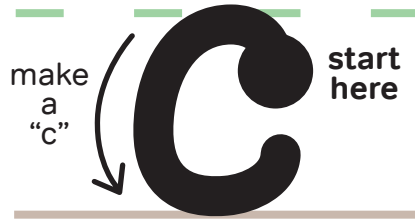

cake

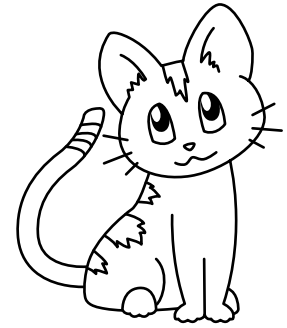

cat



Write a lowercase letter **c** at each dot.



Write 10 curvy **c**'s all on your own.



NAME: _____

DATE: _____

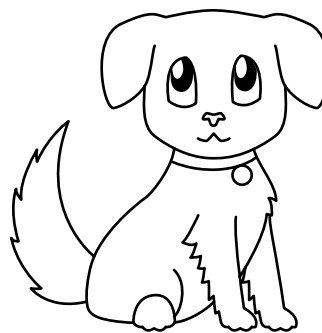
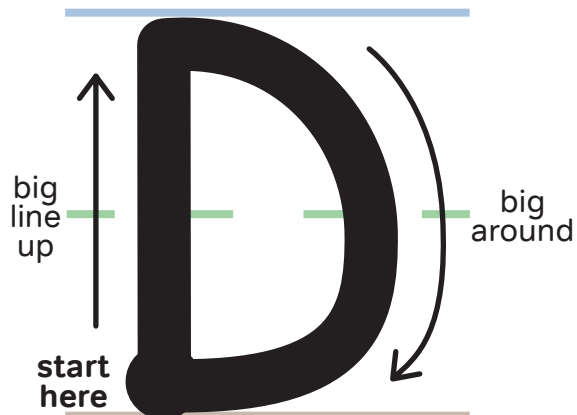

dog

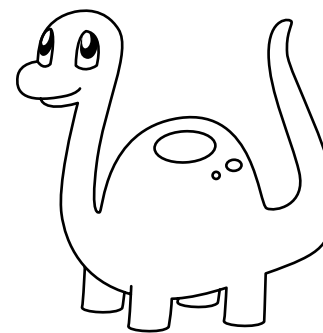

dinosaur

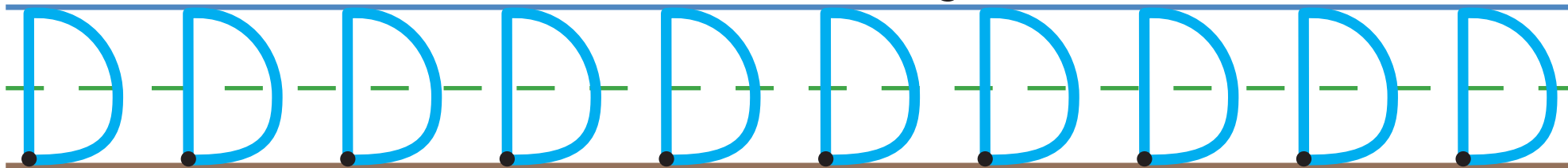

Write an uppercase letter **D** at each dot.

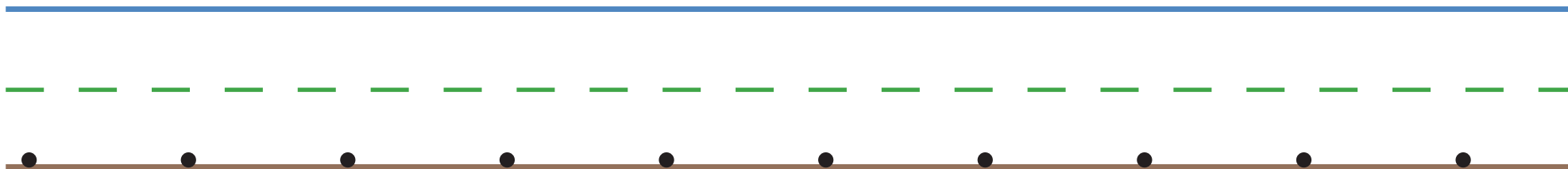

Write 10 dandy **D**'s all on your own.



NAME: _____

DATE: _____

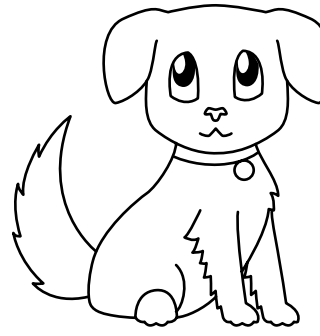
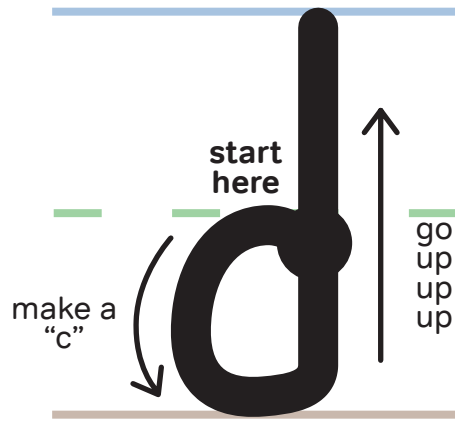

dog

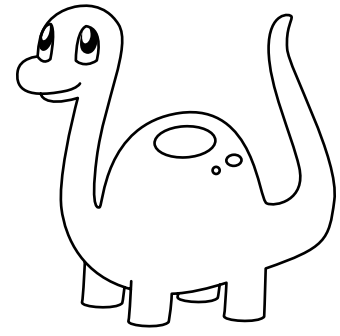

dinosaur

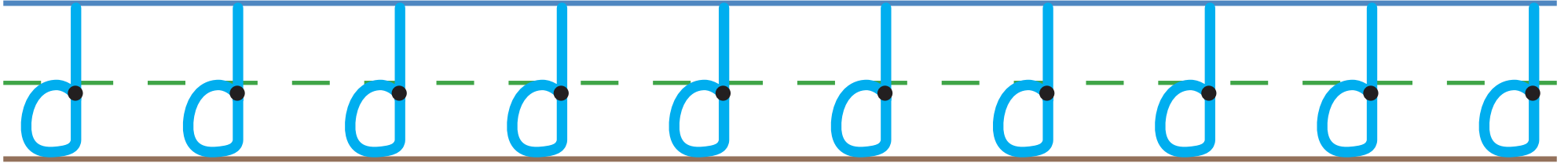

Write a lowercase letter **d** at each dot.

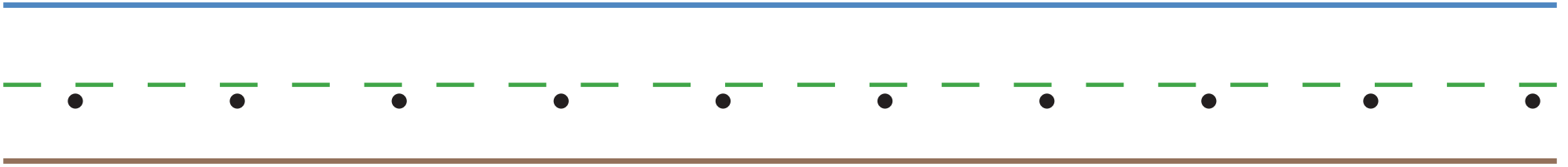

Write 10 dandy **d**'s all on your own.

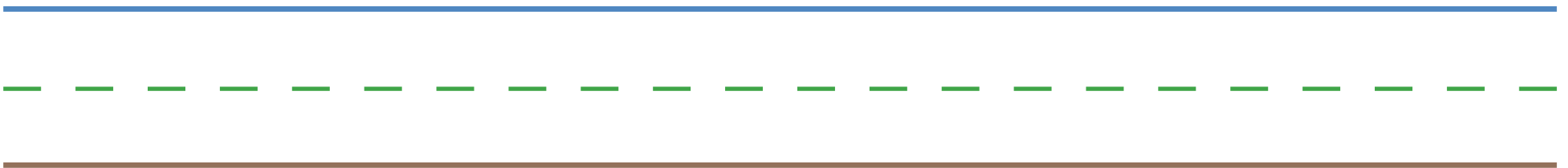

NAME: _____

DATE: _____

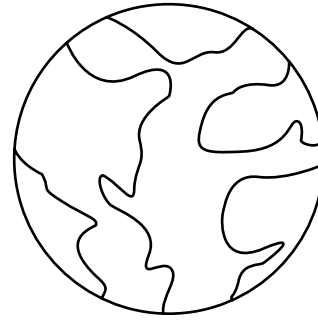
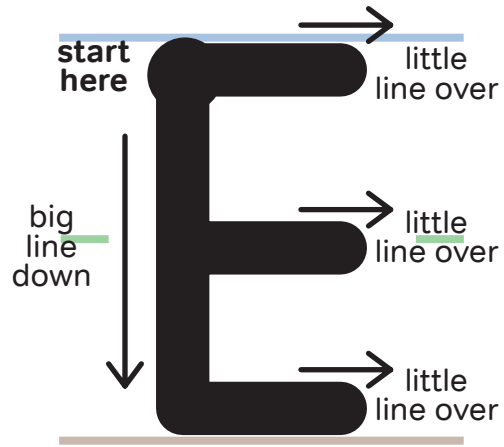

earth

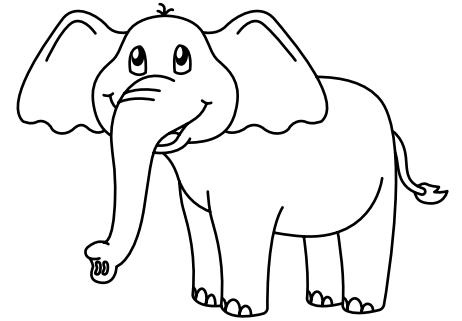

elephant

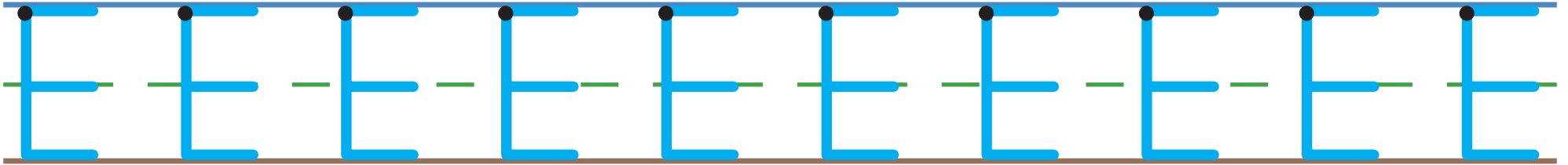

Write an uppercase letter **E** at each dot.

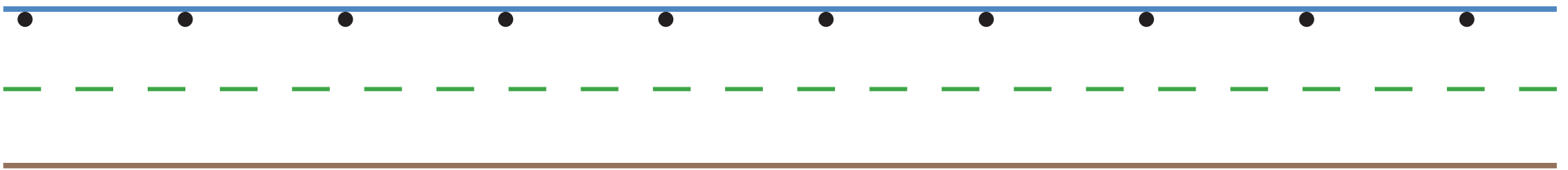

Write 10 epic **E**'s all on your own.

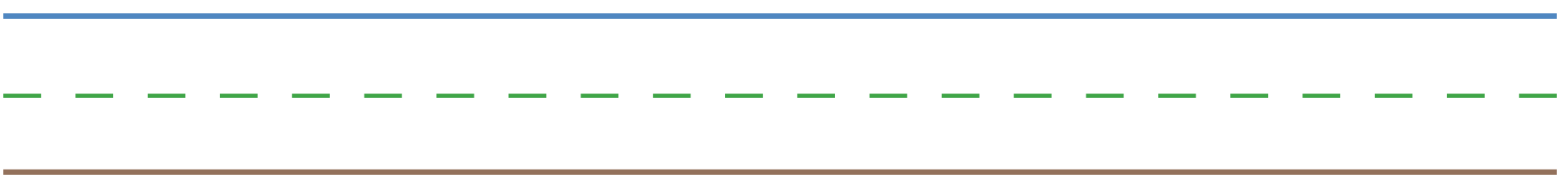

NAME: _____

DATE: _____

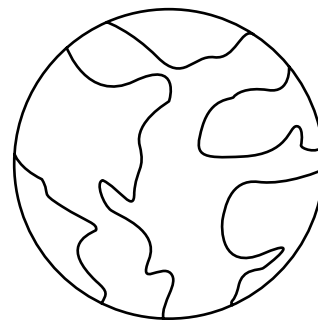
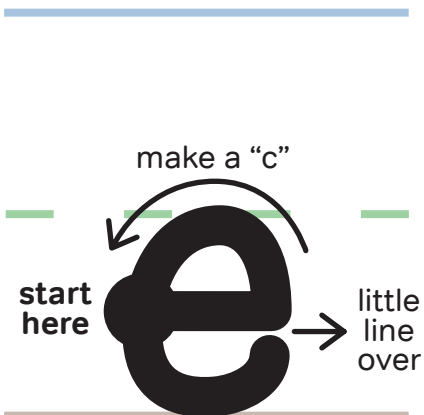

earth

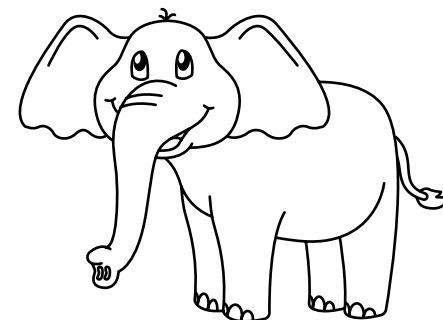

elephant



Write a lowercase letter **e** at each dot.



Write 10 epic **e**'s all on your own.



NAME: _____

DATE: _____

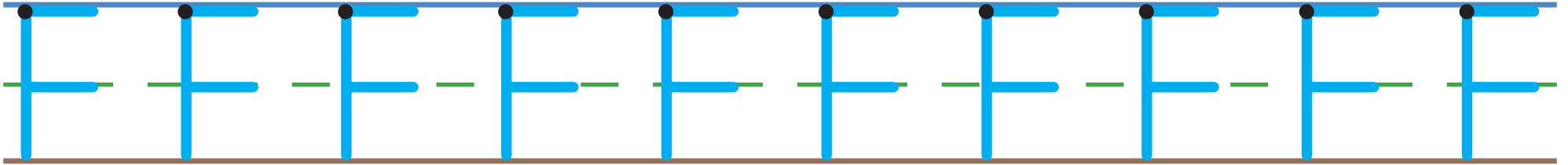
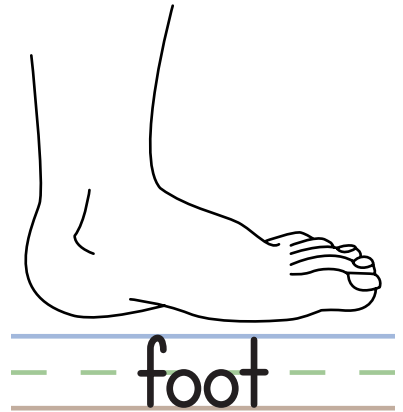
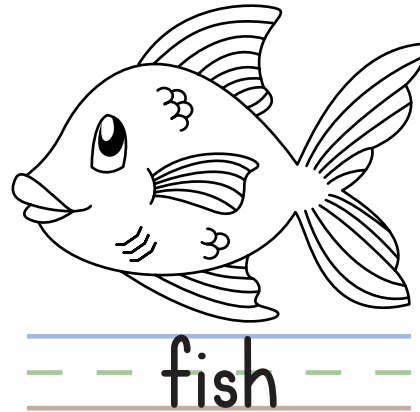
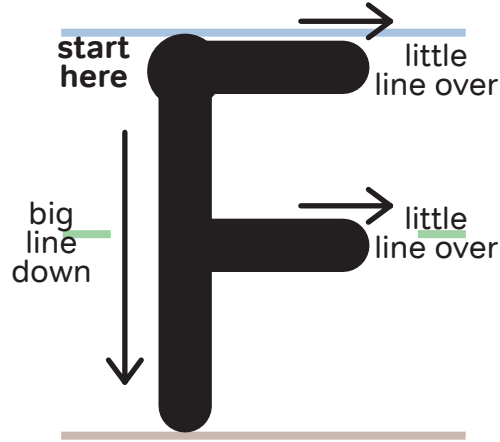

Write an uppercase letter **F** at each dot.

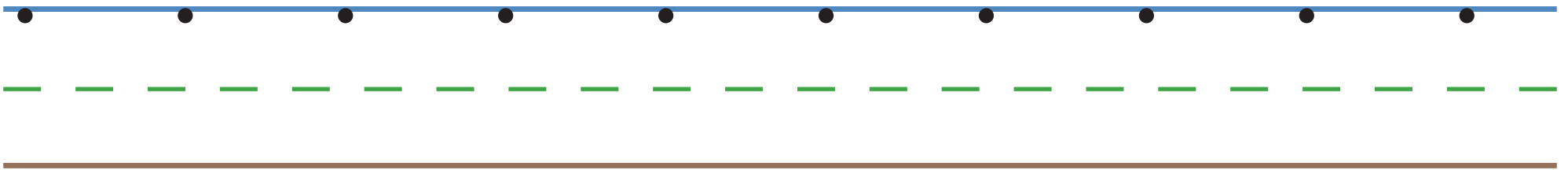

Write 10 fabulous **F**'s all on your own.



NAME: _____

DATE: _____

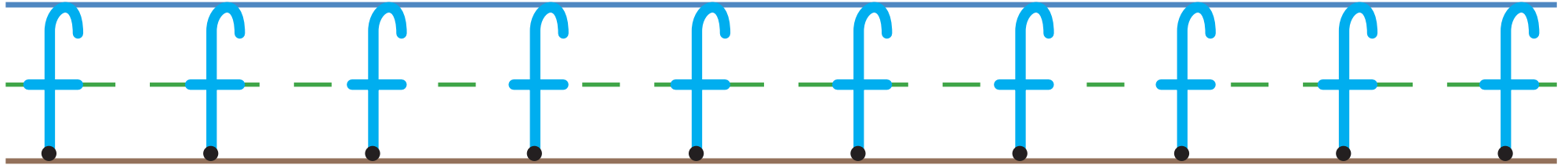
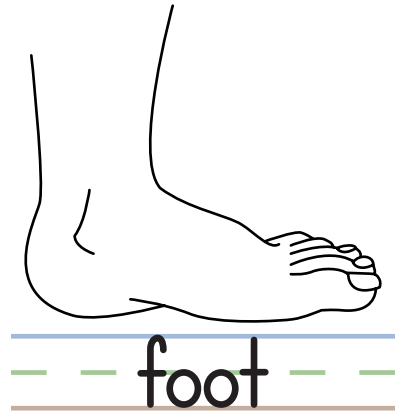
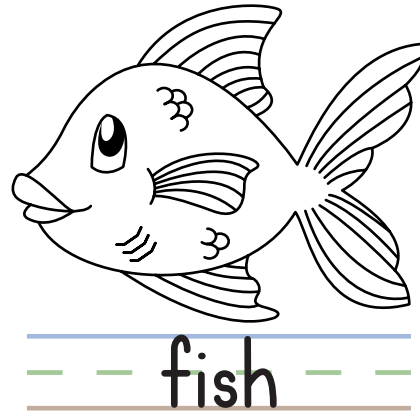
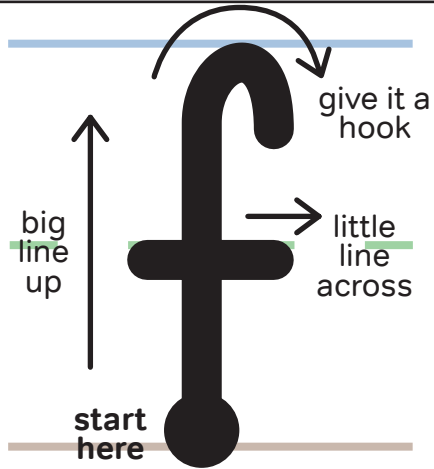

Write a lowercase letter **f** at each dot.

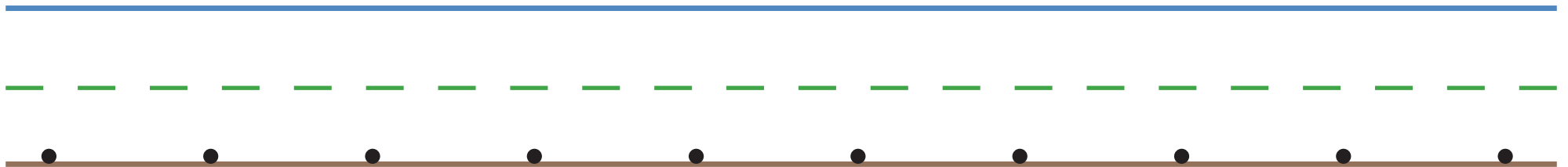

Write 10 fabulous **f**'s all on your own.

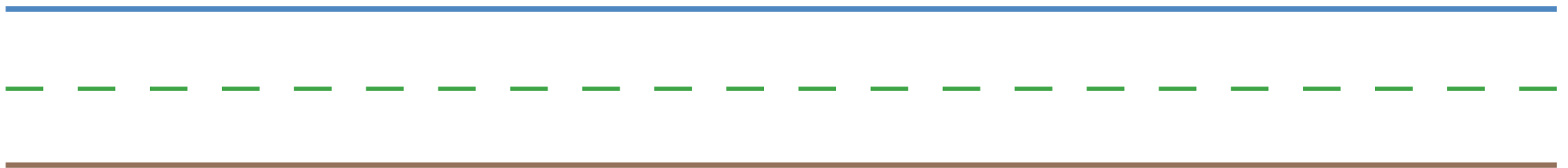

NAME: _____

DATE: _____

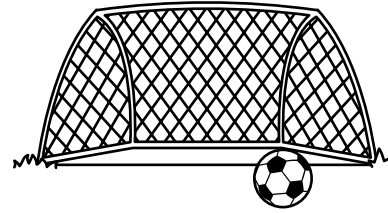
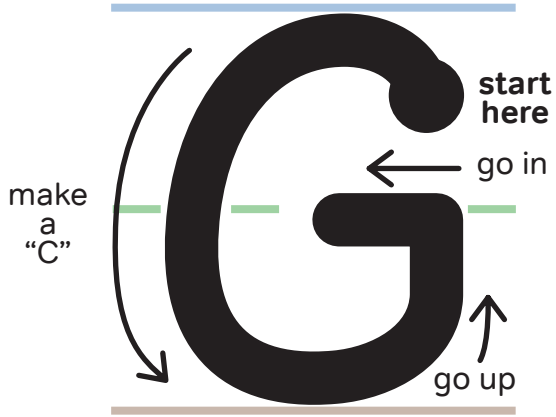

goal

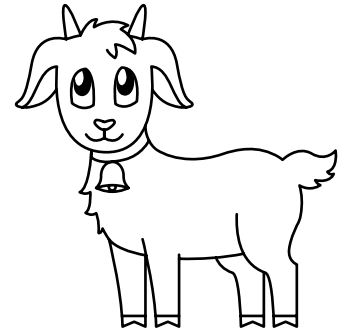

goat



Write an uppercase letter **G** at each dot.

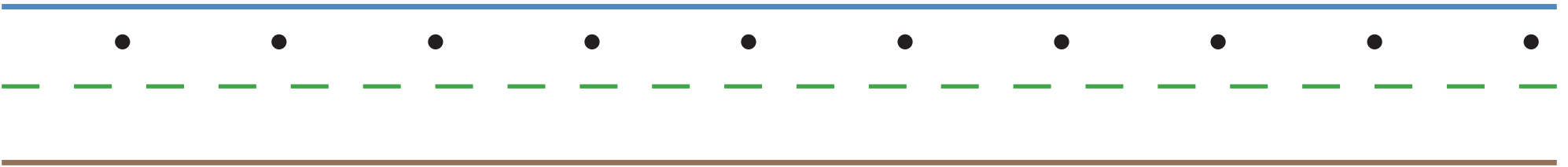

Write 10 great **G**'s all on your own.

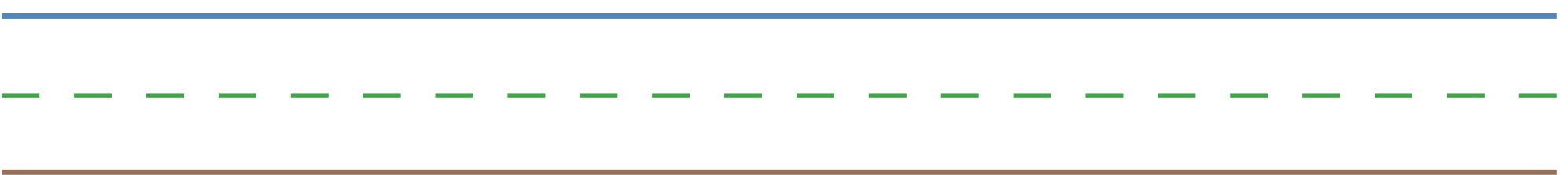

NAME: _____

DATE: _____

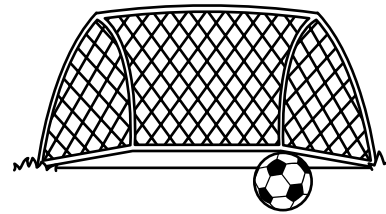
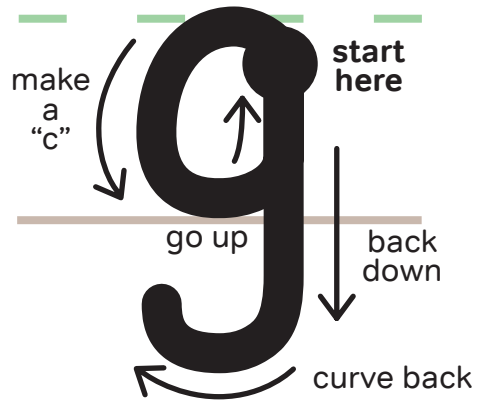

goal

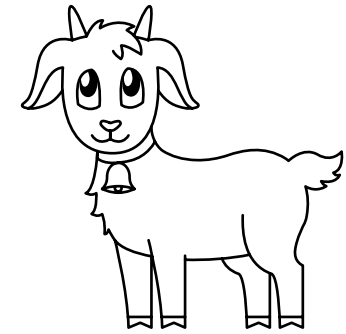

goat

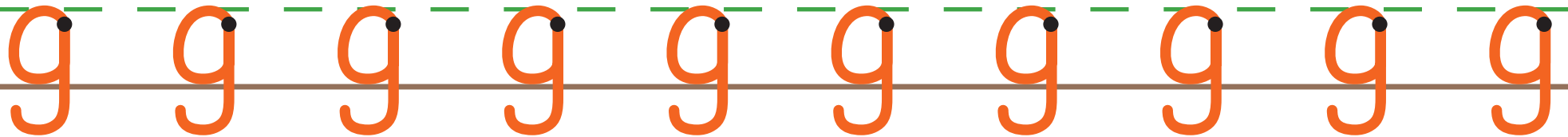

Write a lowercase letter **g** at each dot.



Write 10 great **g**'s all on your own.



NAME: _____

DATE: _____

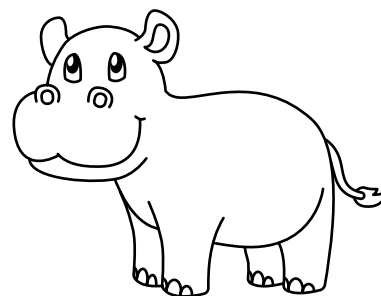
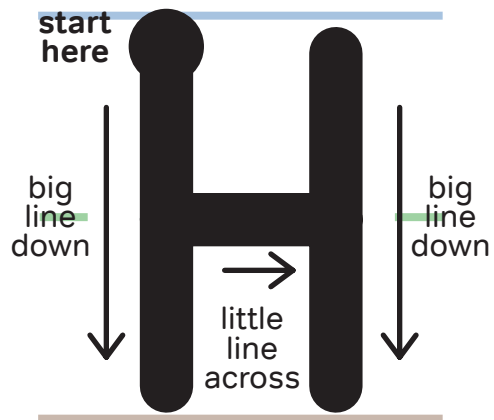

hippo



house

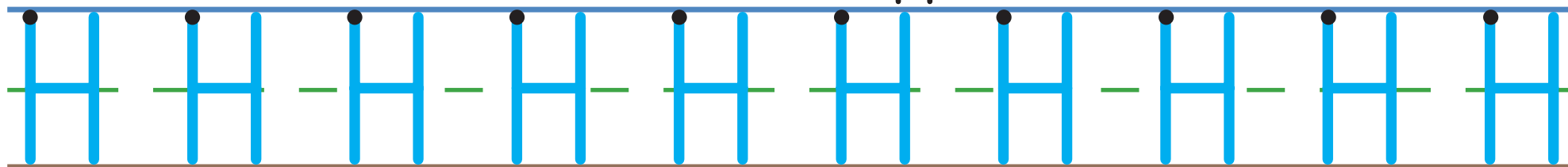

Write an uppercase letter **H** at each dot.

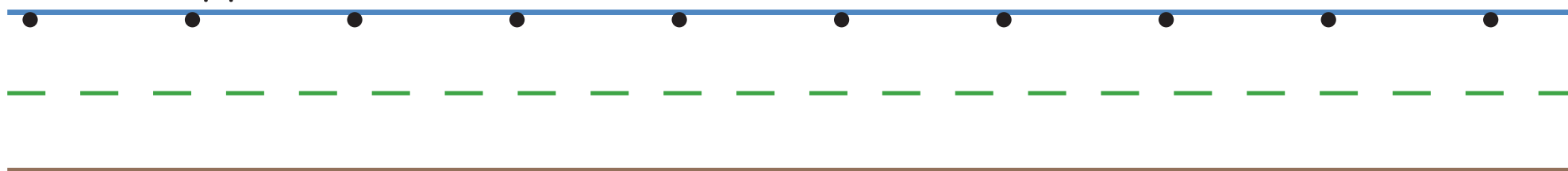

Write 10 happy **H**'s all on your own.



NAME: _____

DATE: _____

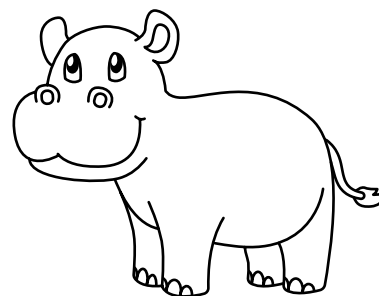
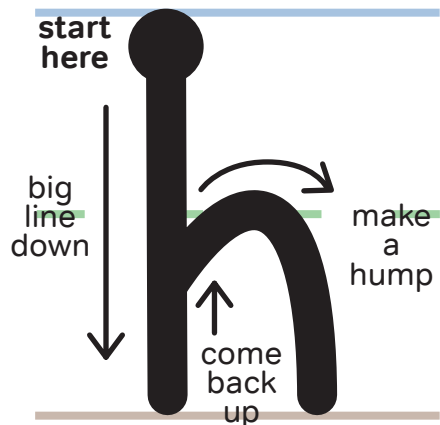

hippo



house

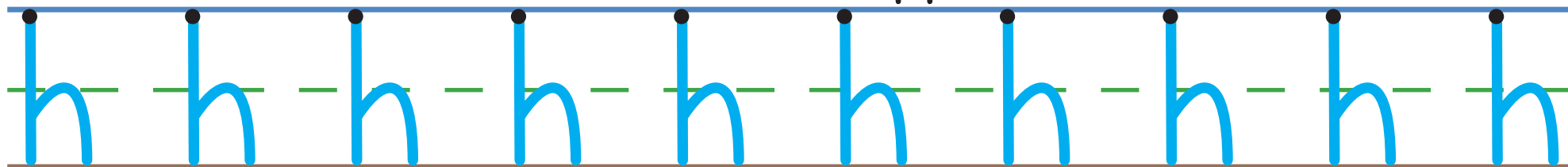

Write a lowercase letter **h** at each dot.

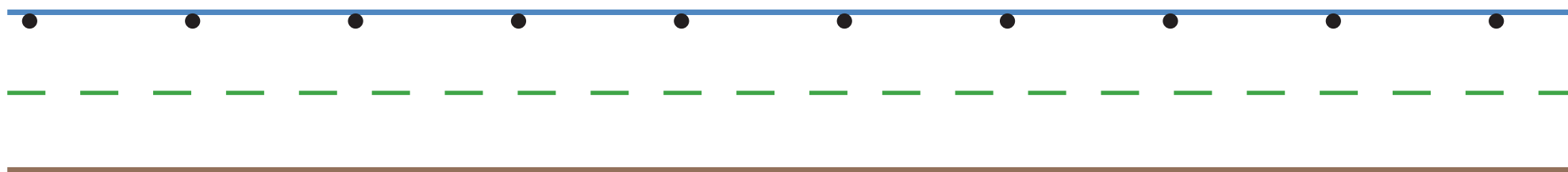

Write 10 happy **h**'s all on your own.



NAME: _____

DATE: _____

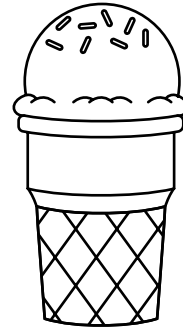
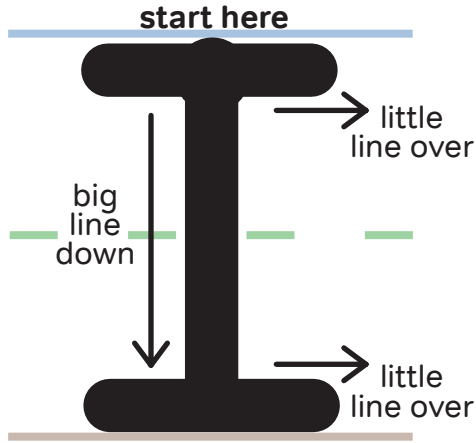

icecream

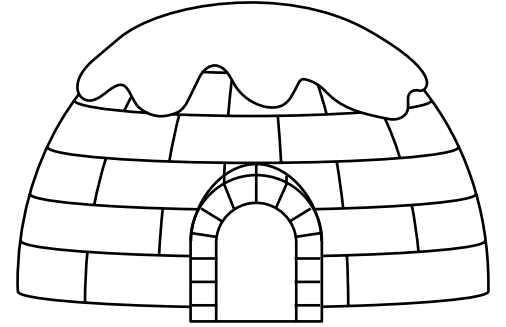

igloo

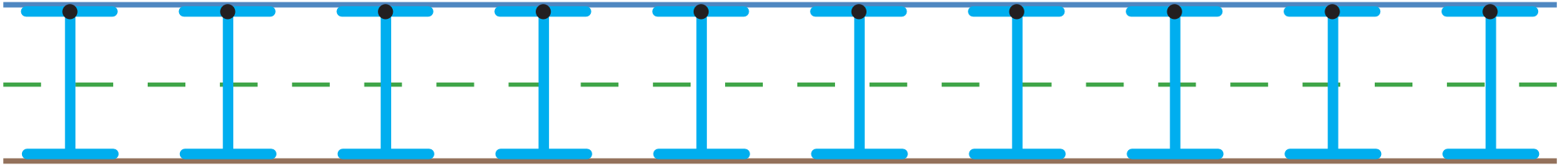

Write an uppercase letter **I** at each dot.

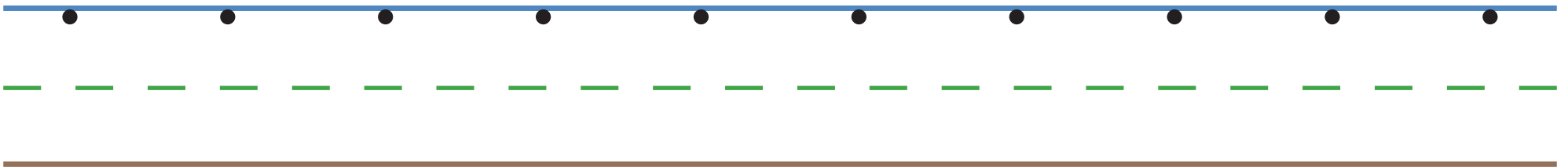

Write 10 incredible **I**'s all on your own.



NAME: _____

DATE: _____

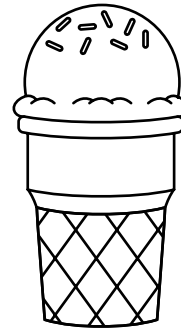
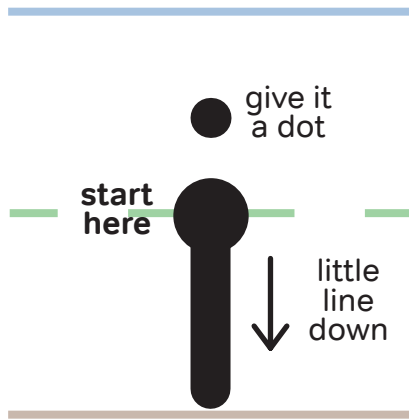

icecream

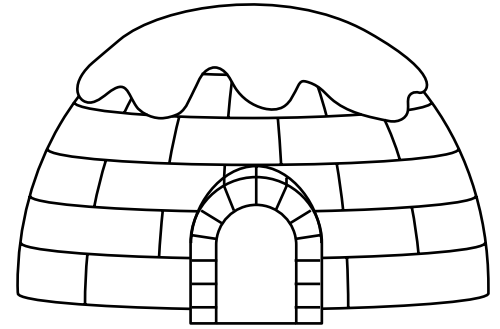

igloo

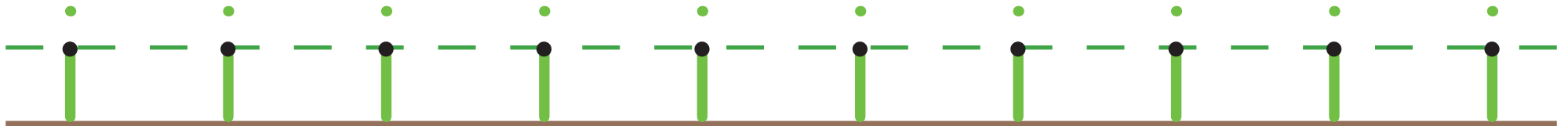

Write a lowercase letter i at each dot.



Write 10 incredible i's all on your own.



NAME: _____

DATE: _____

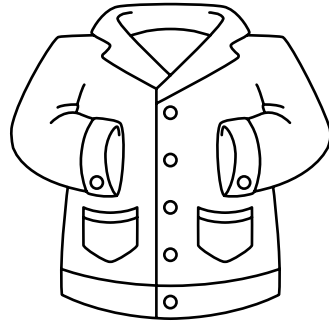
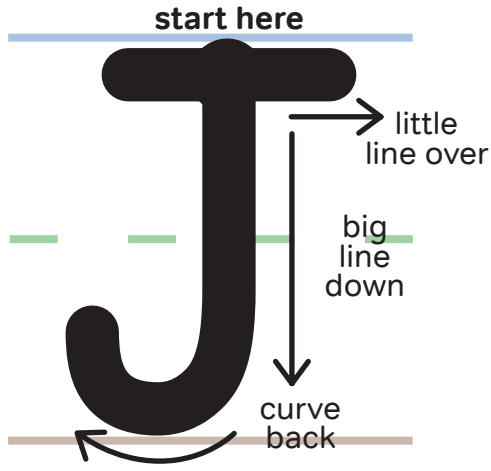

jacket

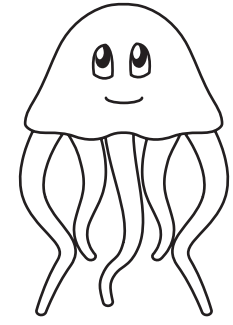

jellyfish

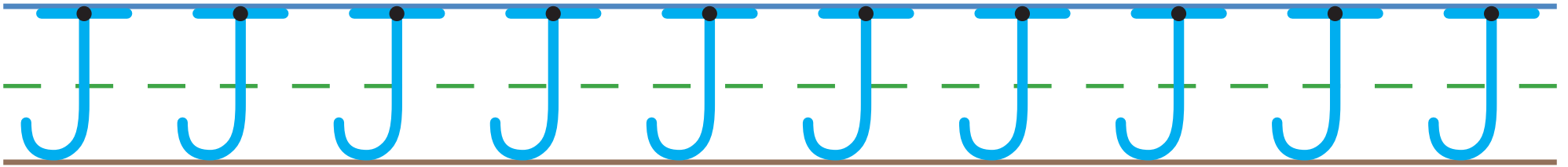

Write an uppercase letter **J** at each dot.

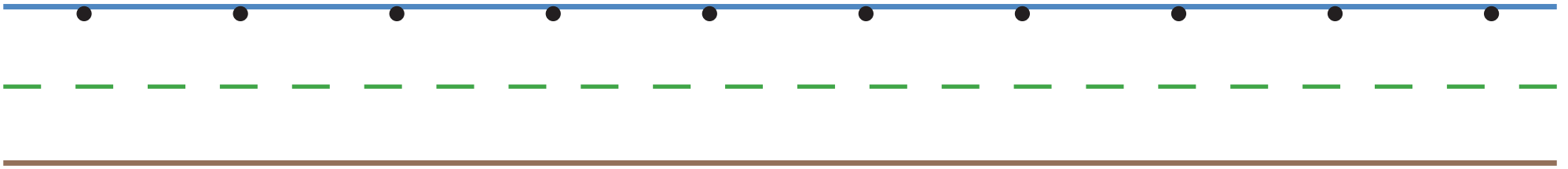

Write 10 jazzy **J**'s all on your own.



NAME: _____

DATE: _____

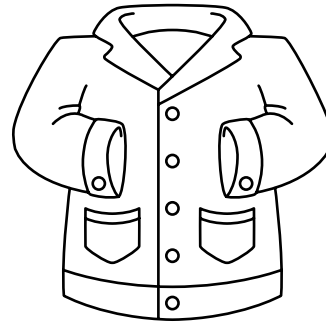
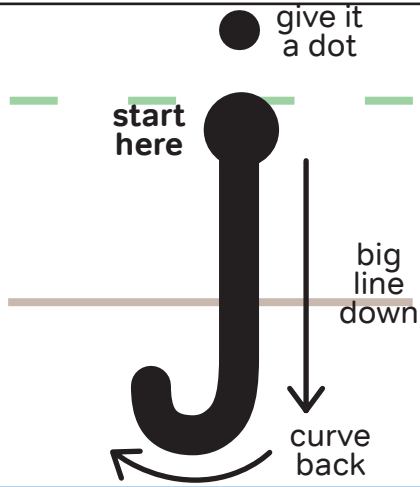

jacket

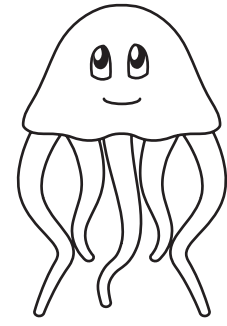

jellyfish

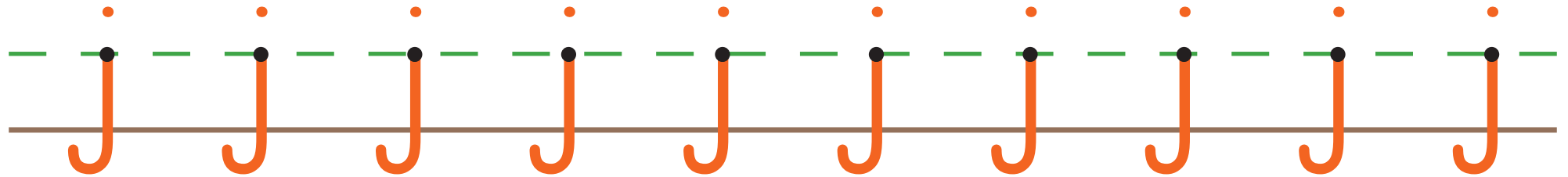

Write a lowercase letter j at each dot.

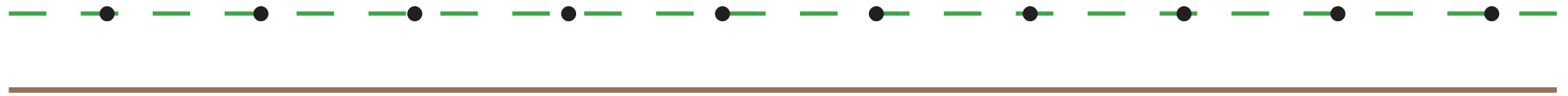

Write 10 jazzy j's all on your own.



NAME: _____

DATE: _____

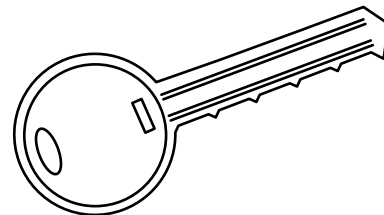
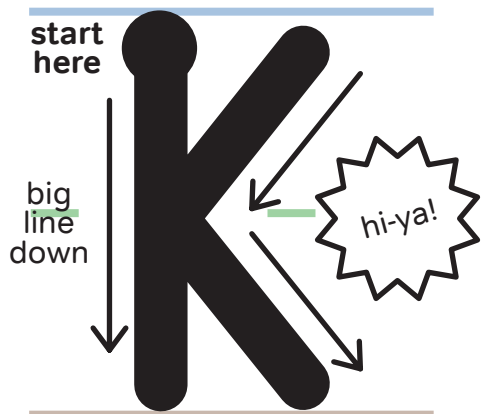

key

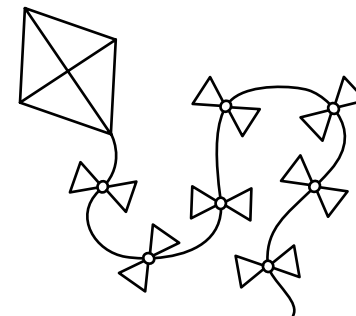

kite

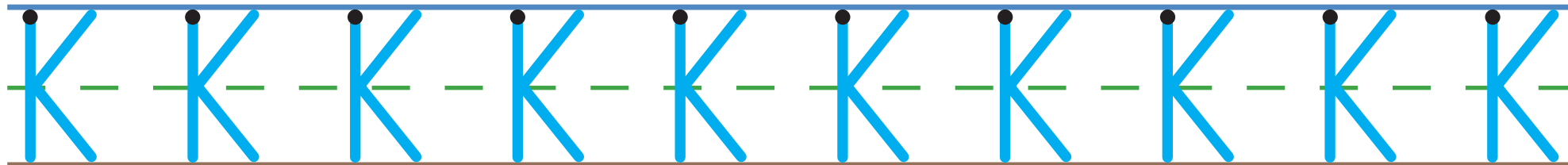

Write an uppercase letter **K** at each dot.

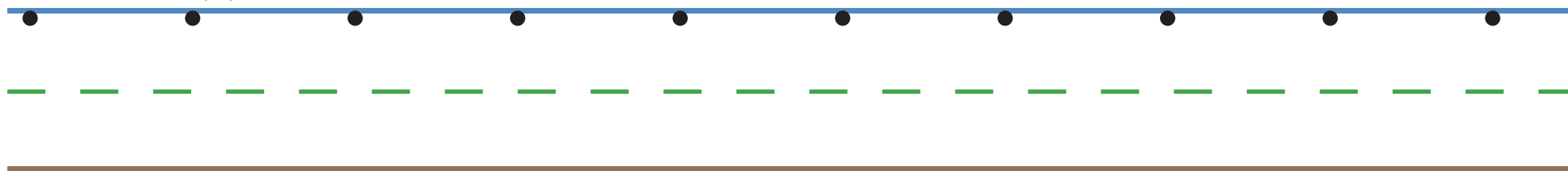

Write 10 kicky **K**'s all on your own.



NAME: _____

DATE: _____

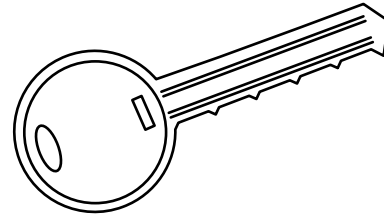
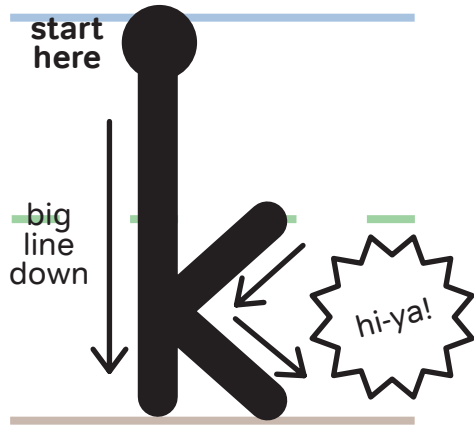

key

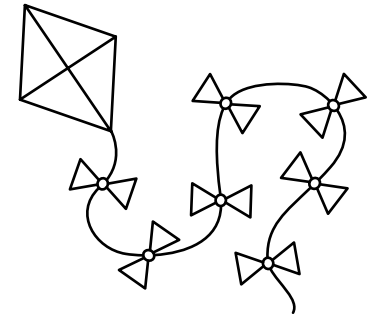

kite

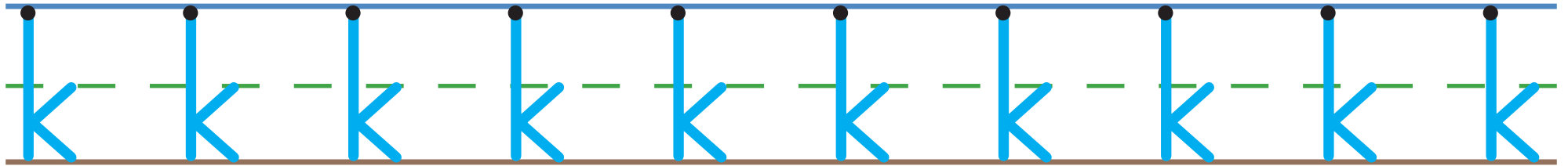

Write a lowercase letter **k** at each dot.

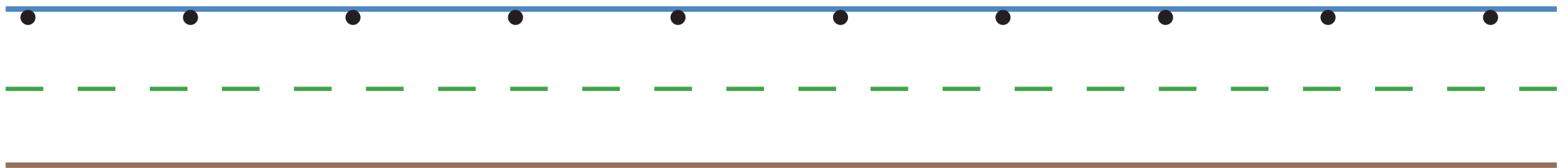

Write 10 kicky **k**'s all on your own.



NAME: _____

DATE: _____

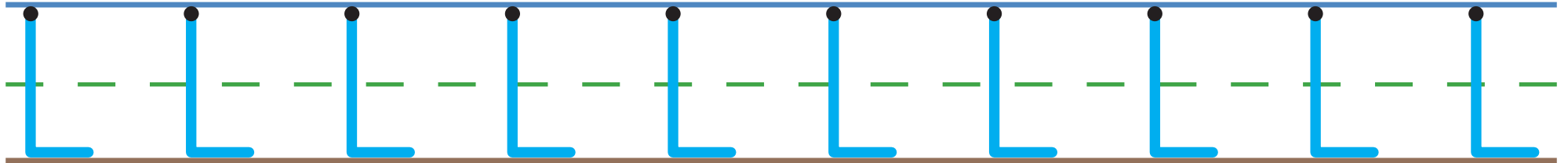
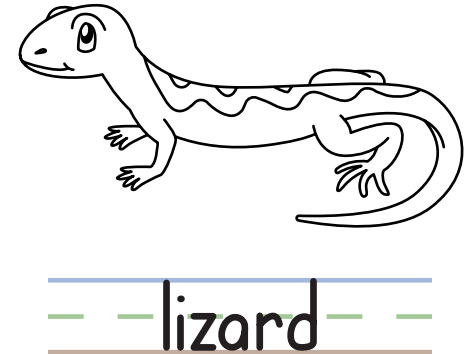
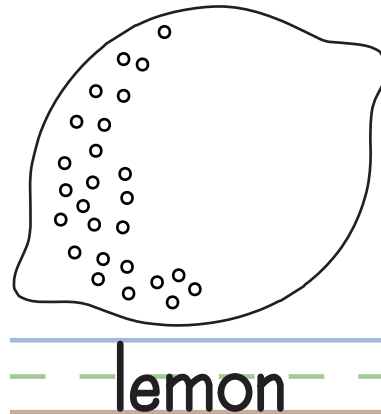
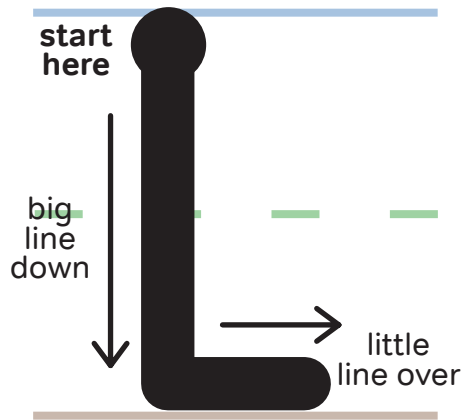

Write an uppercase letter L at each dot.

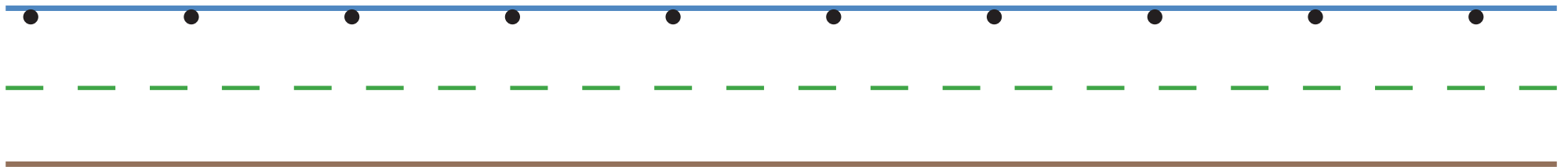

Write 10 lovely L's all on your own.



NAME: _____

DATE: _____

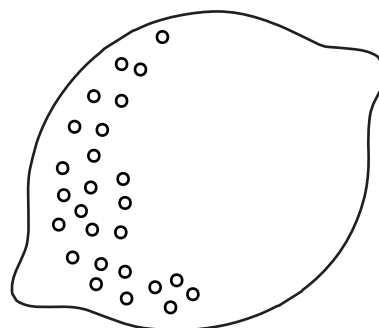
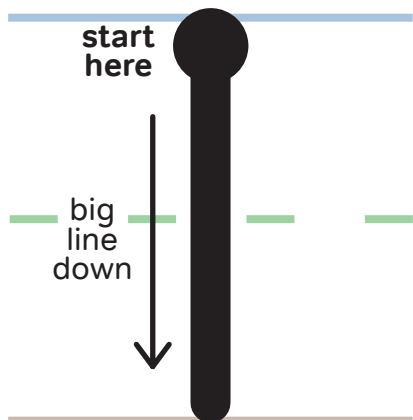

lemon

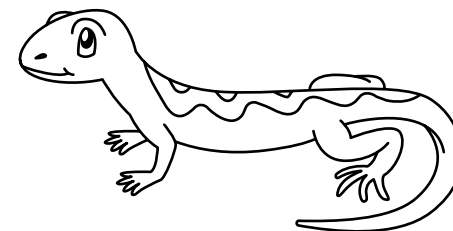

lizard

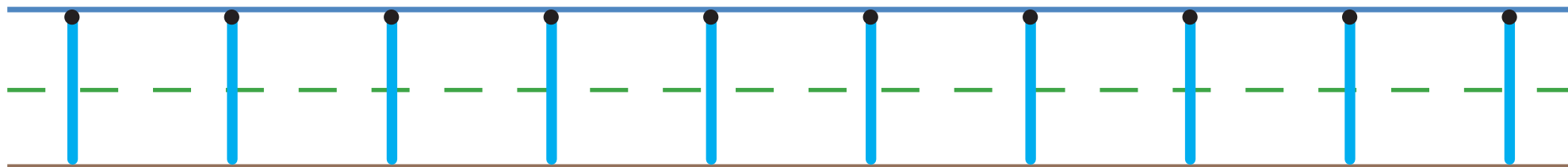

Write a lowercase letter l at each dot.

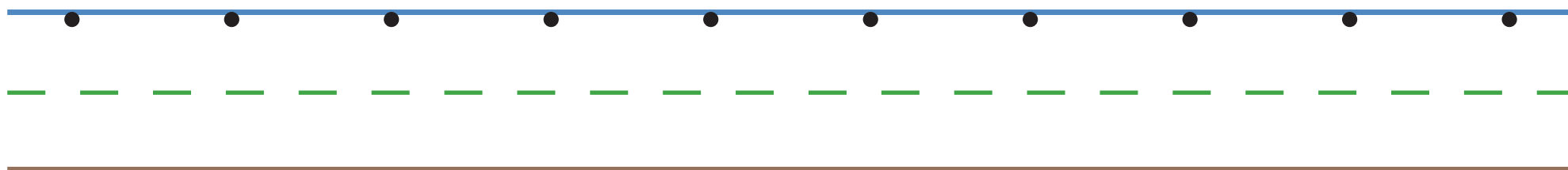

Write 10 lovely l's all on your own.



NAME: _____

DATE: _____

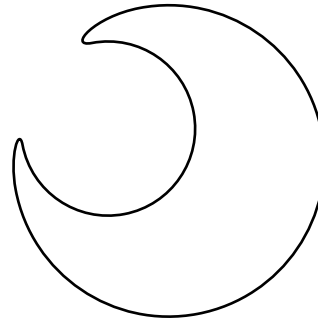
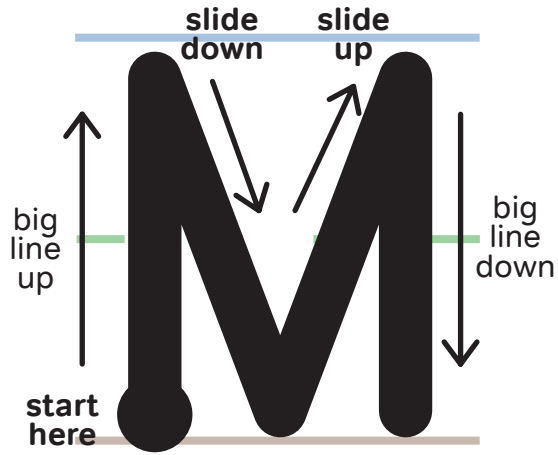

moon

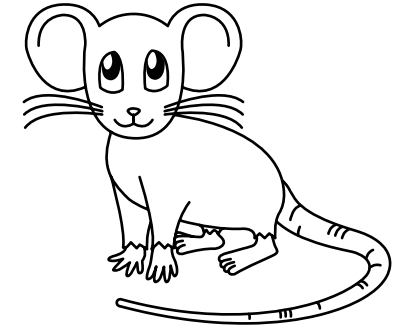

mouse

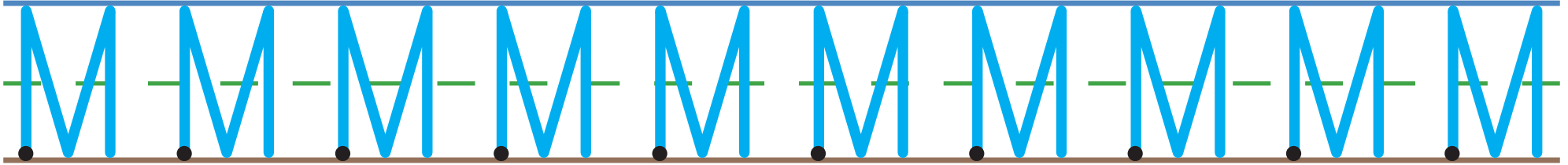

Write an uppercase letter **M** at each dot.

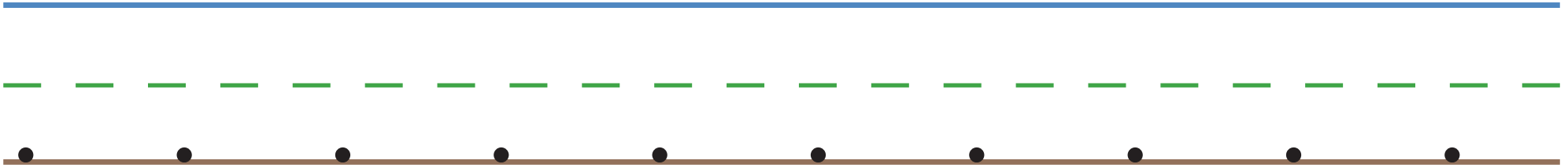

Write 10 mighty **M**'s all on your own.

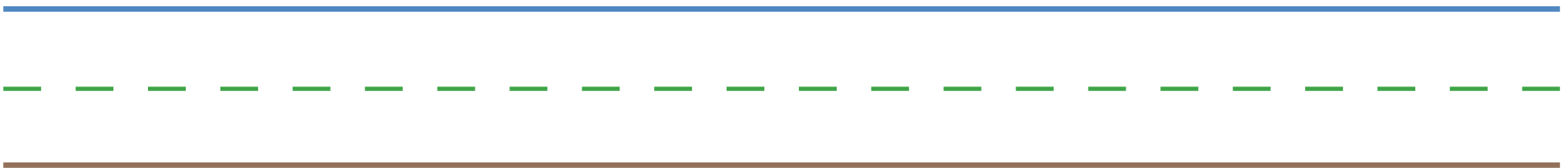

NAME: _____

DATE: _____

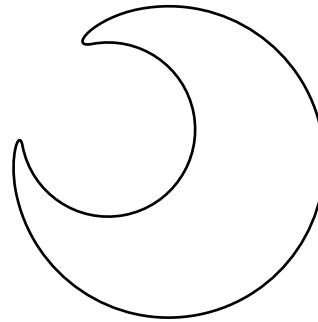
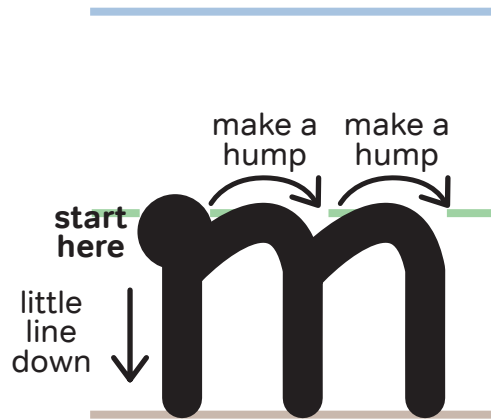

moon

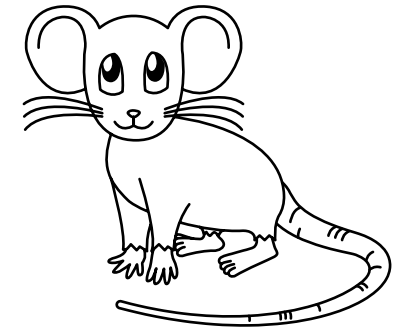

mouse

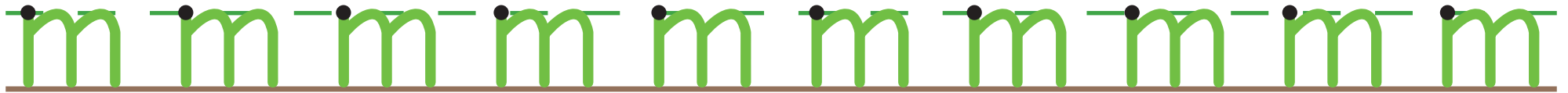

Write a lowercase letter **m** at each dot.

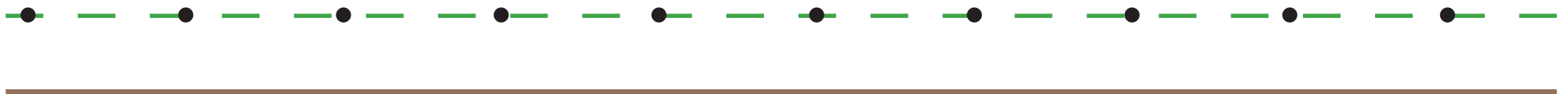

Write 10 mighty **m**'s all on your own.



NAME: _____

DATE: _____

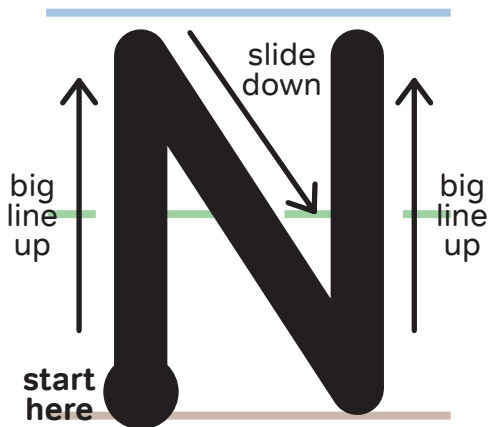

necklace

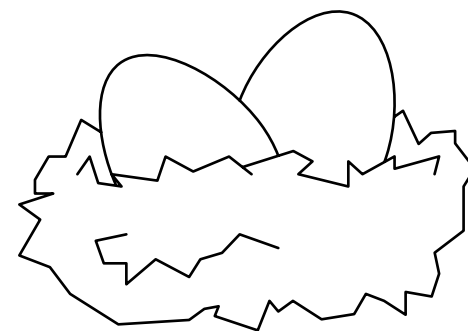

nest

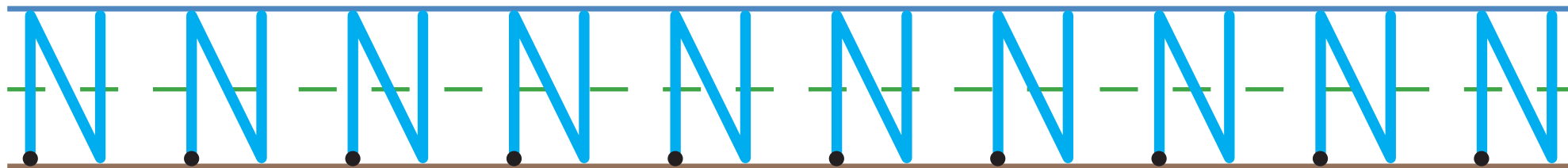

Write an uppercase letter N at each dot.

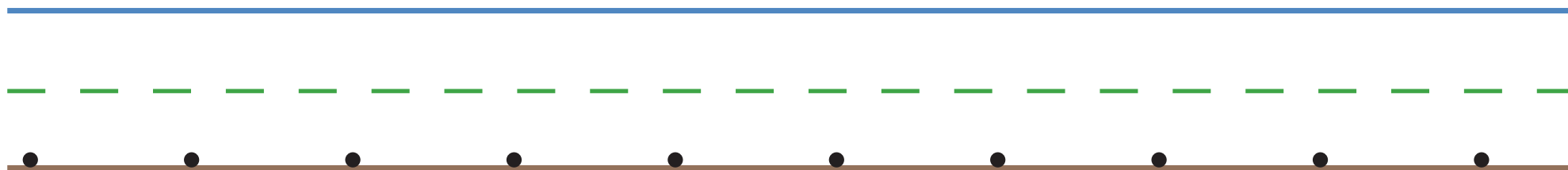

Write 10 neat N's all on your own.



NAME: _____

DATE: _____

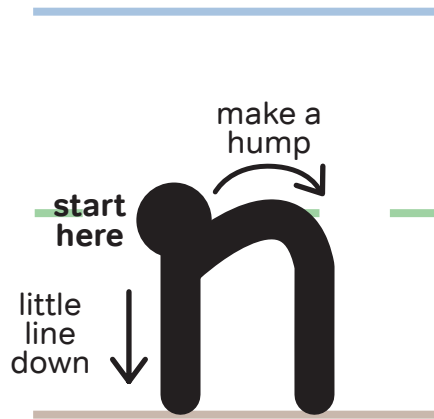

necklace

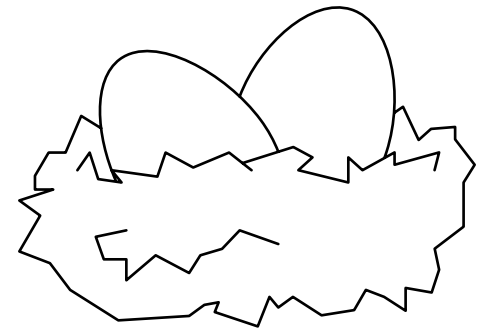

nest



Write a lowercase letter **n** at each dot.



Write 10 neat **n**'s all on your own.

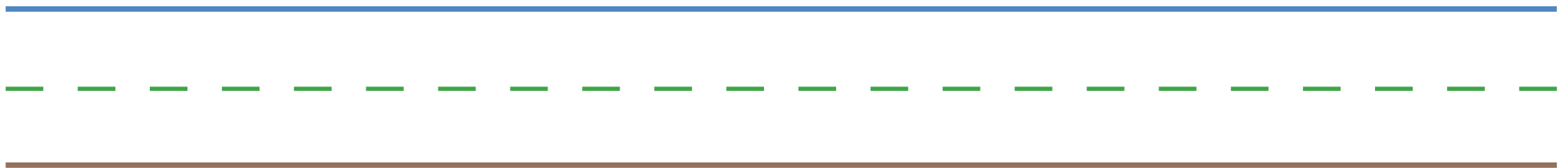

NAME: _____

DATE: _____

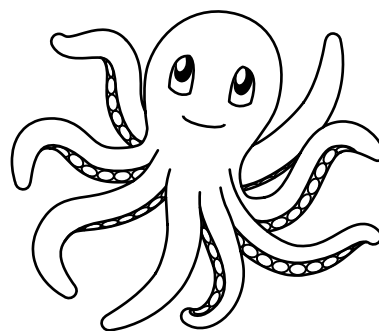
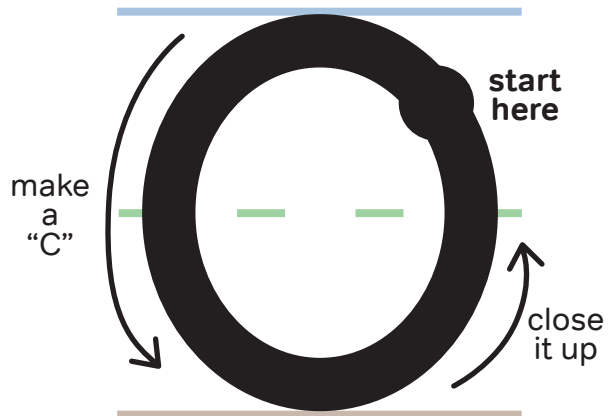

octopus

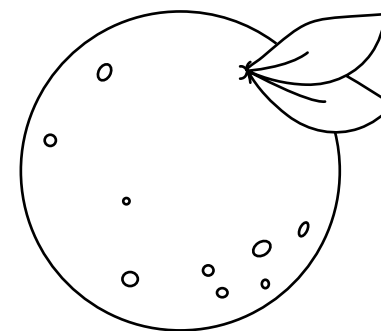

orange

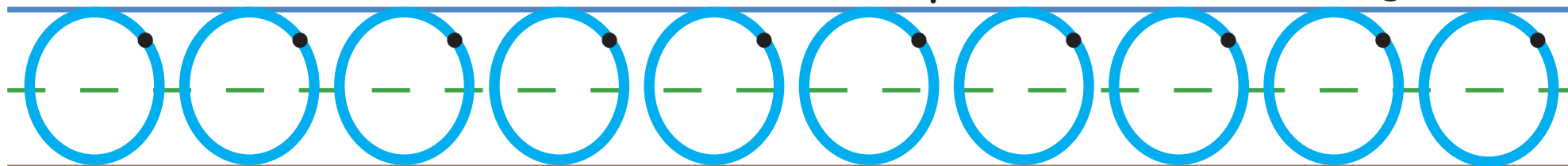

Write an uppercase letter O at each dot.

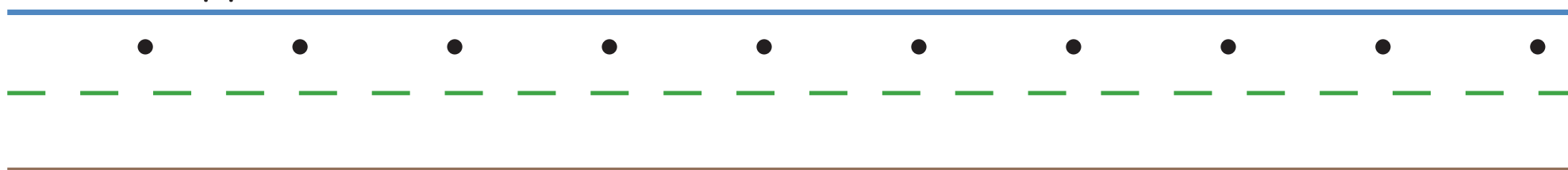

Write 10 outstanding O's all on your own.



NAME: _____

DATE: _____

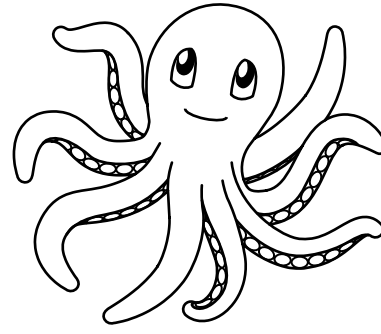

octopus

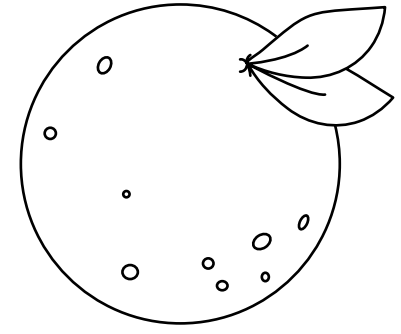

orange



Write a lowercase letter o at each dot.



Write 10 outstanding o's all on your own.



NAME: _____

DATE: _____

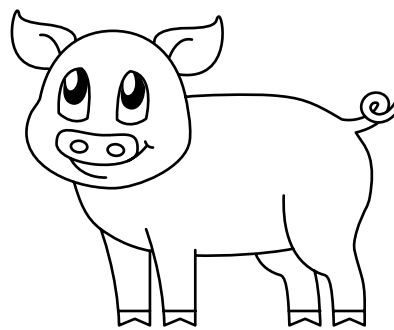
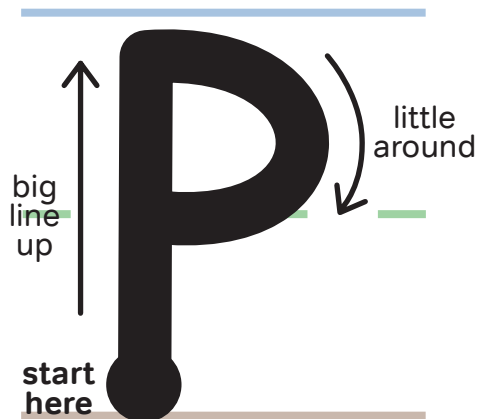

pig

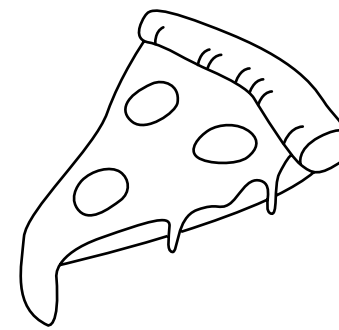

pizza

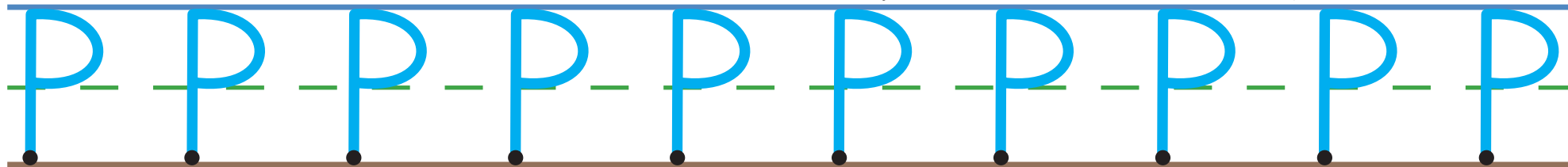

Write an uppercase letter **P** at each dot.

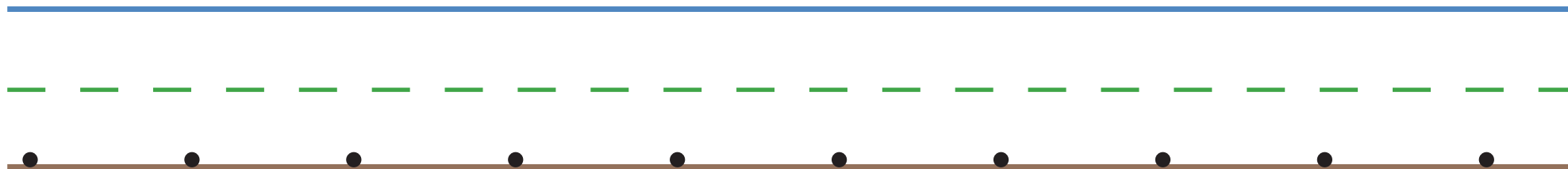

Write 10 pretty **P**'s all on your own.



NAME: _____

DATE: _____

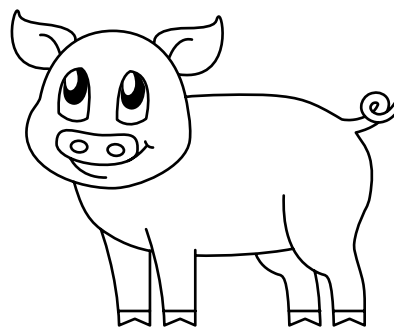
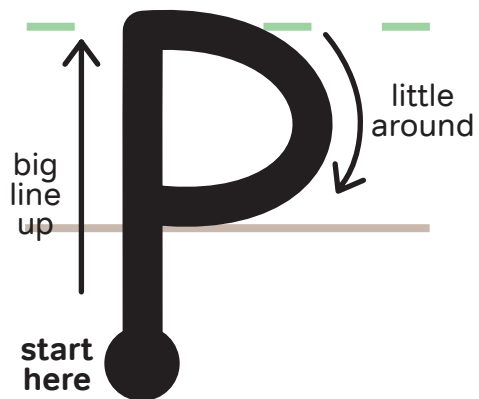

pig

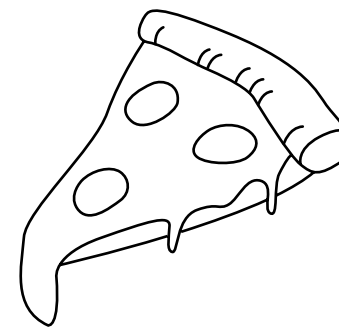

pizza

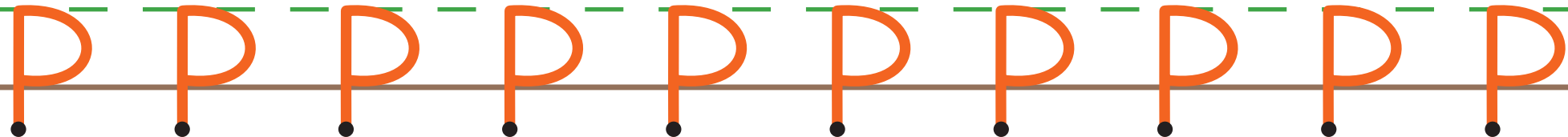

Write a lowercase letter **p** at each dot.

Write 10 pretty **p**'s all on your own.

NAME: _____

DATE: _____

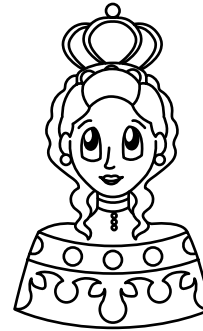
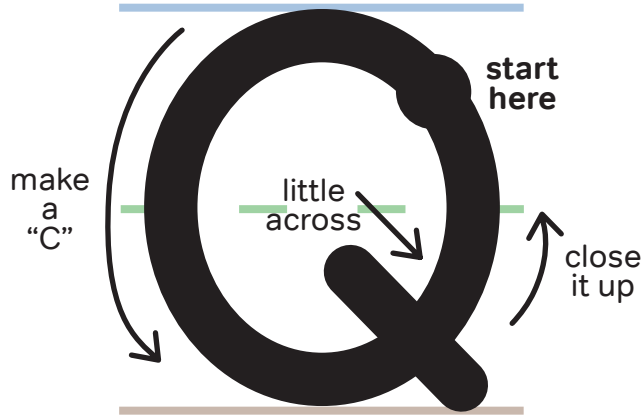

queen

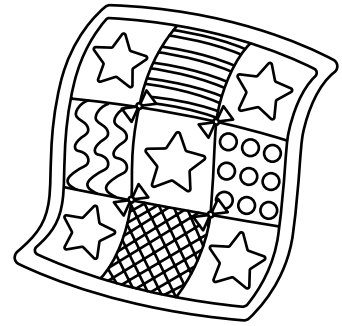

quilt

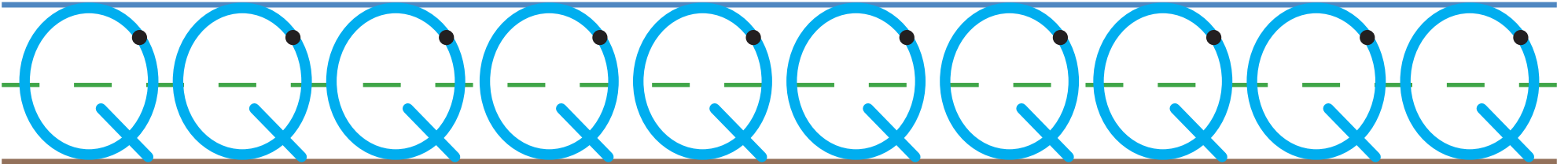

Write an uppercase letter Q at each dot.

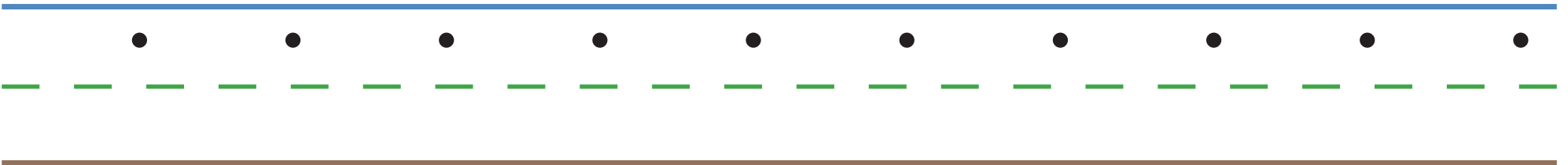

Write 10 quality Q's all on your own.



NAME: _____

DATE: _____

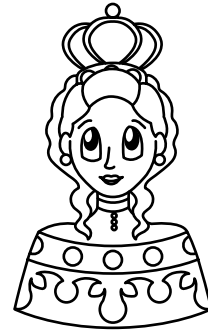
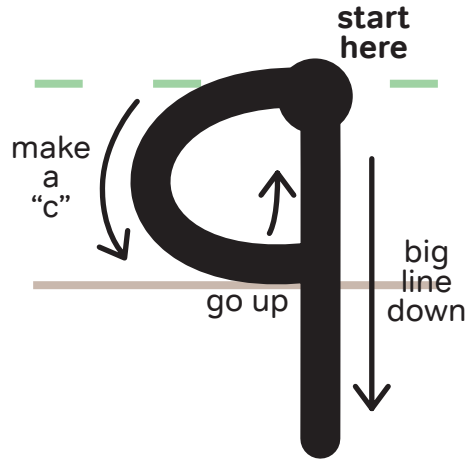

queen

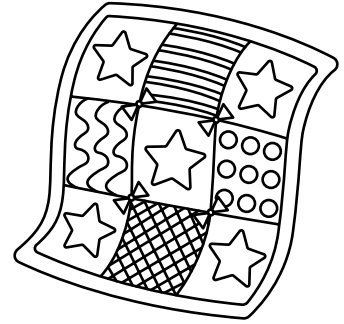

quilt

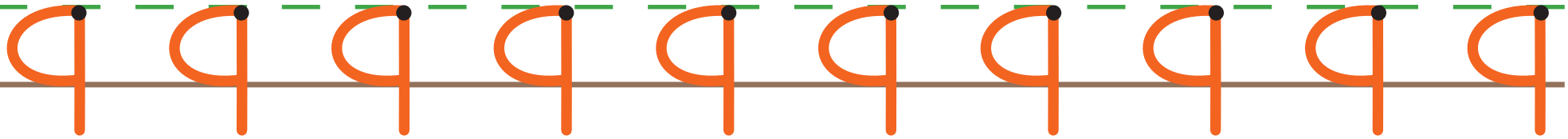

Write a lowercase letter **q** at each dot.



Write 10 quality **q**'s all on your own.

NAME: _____

DATE: _____

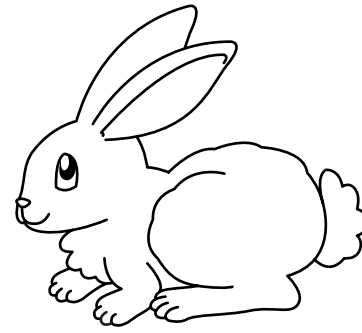
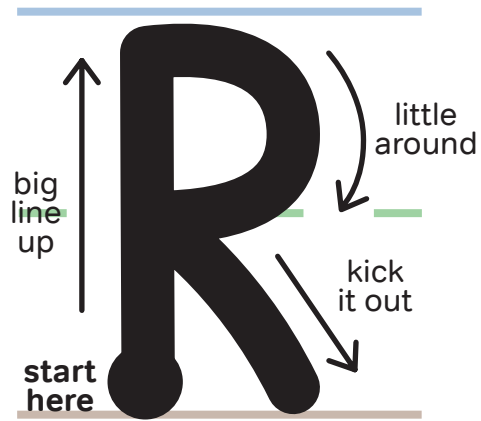

rabbit

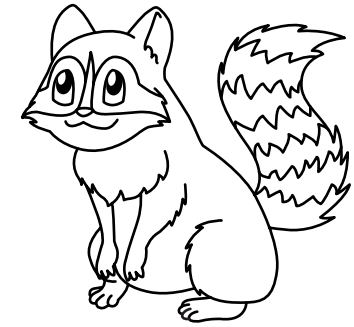

raccoon

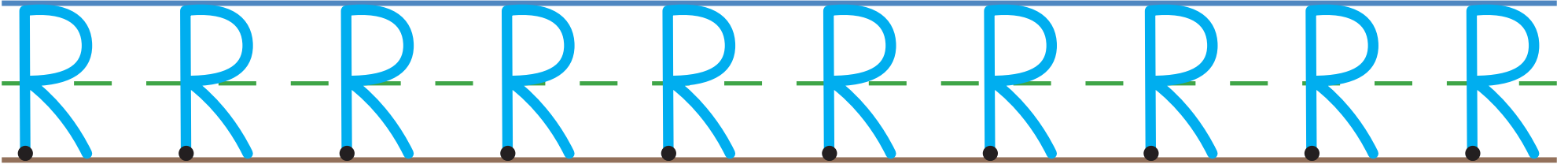

Write an uppercase letter **R** at each dot.

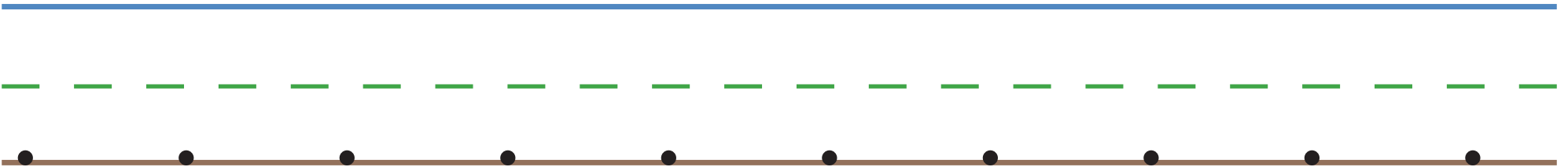

Write 10 radiant **R**'s all on your own.



NAME: _____

DATE: _____

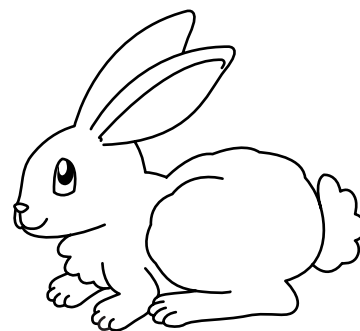
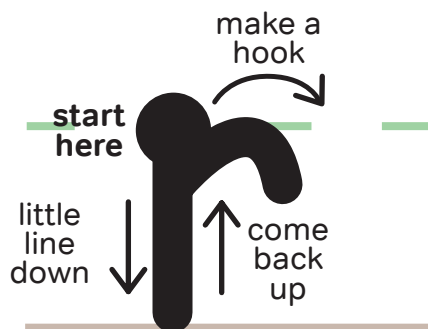

rabbit

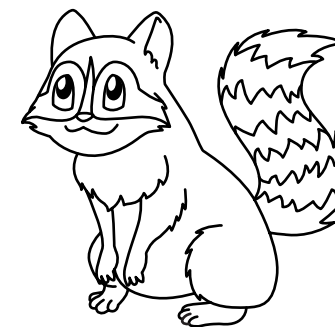

raccoon



Write a lowercase letter r at each dot.



Write 10 radiant r's all on your own.

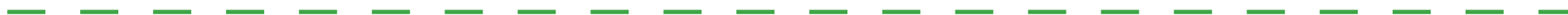

NAME: _____

DATE: _____

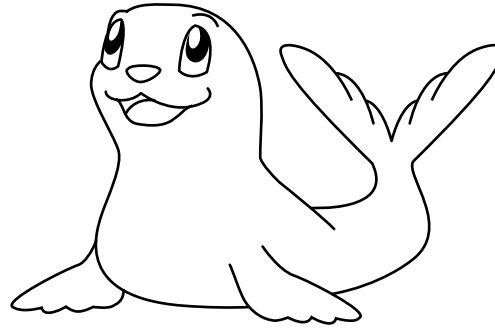
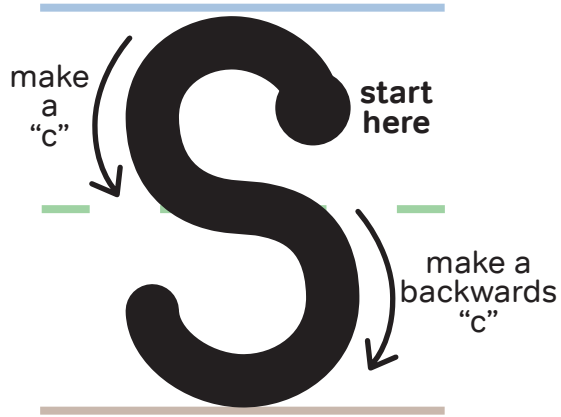

seal



skunk

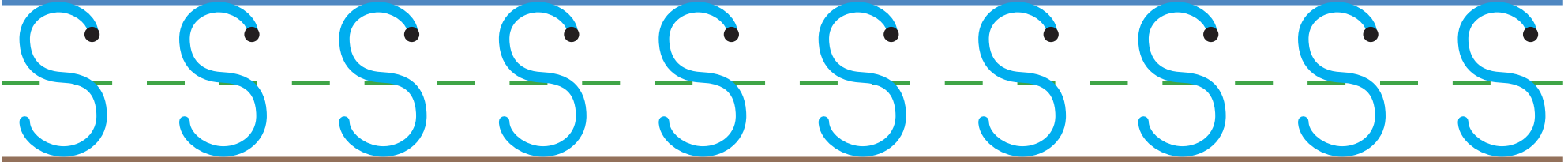

Write an uppercase letter **S** at each dot.

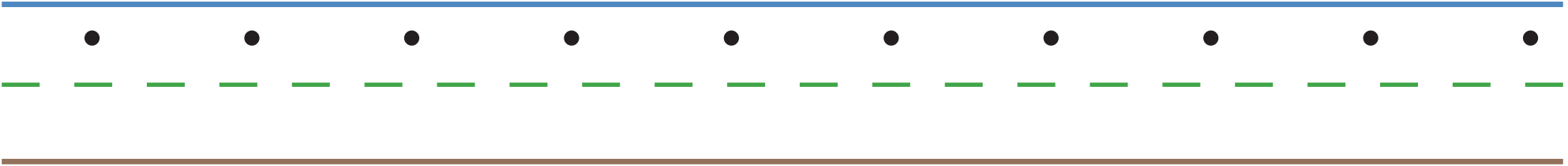

Write 10 super **S**'s all on your own.

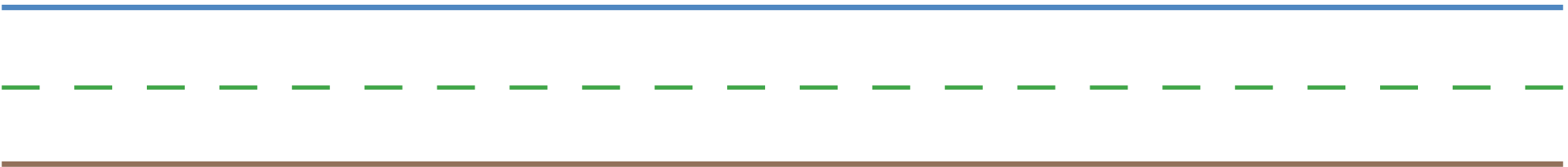

NAME: _____

DATE: _____

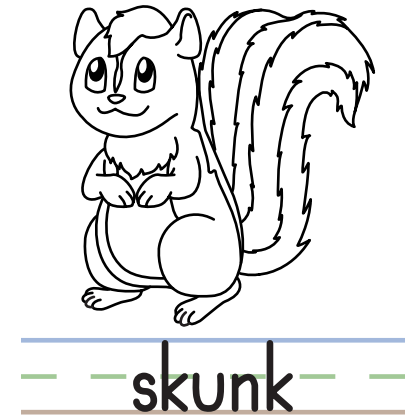
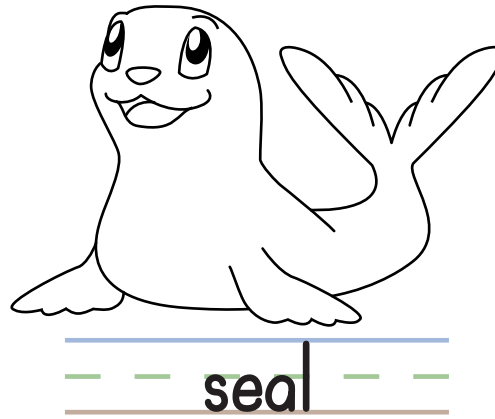

Write a lowercase letter **s** at each dot.



Write 10 super **s**'s all on your own.



NAME: _____

DATE: _____

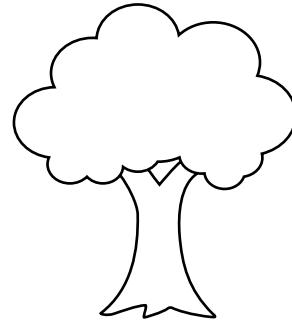
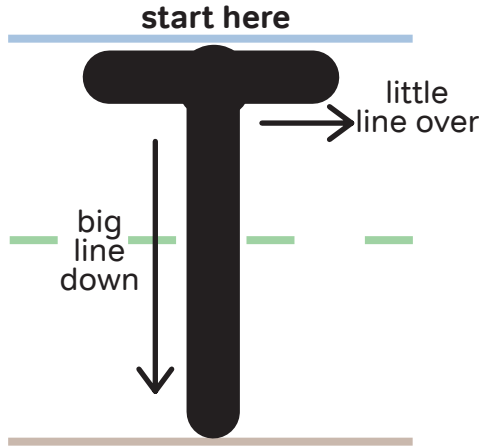

tree

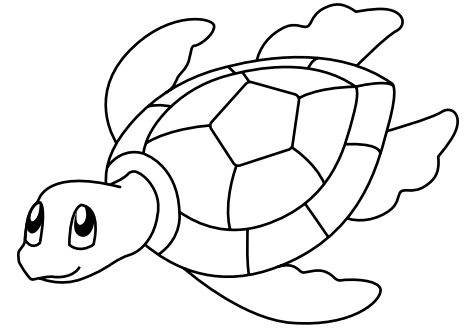

turtle

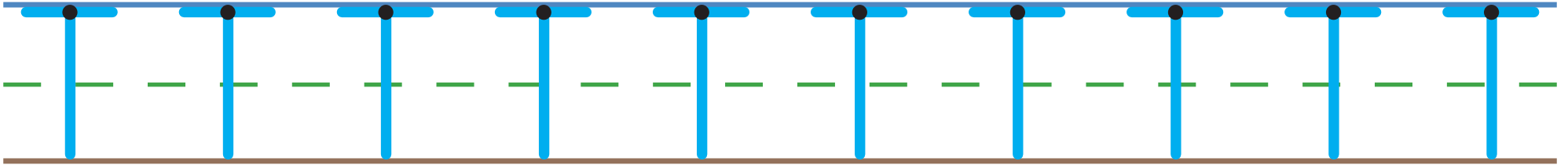

Write an uppercase letter T at each dot.

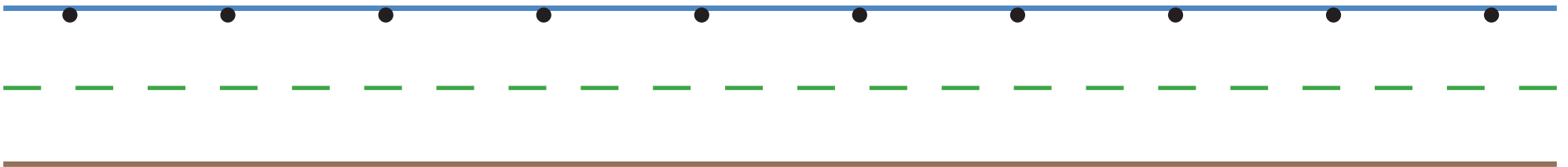

Write 10 tall T's all on your own.



NAME: _____

DATE: _____

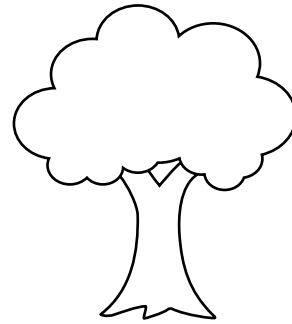
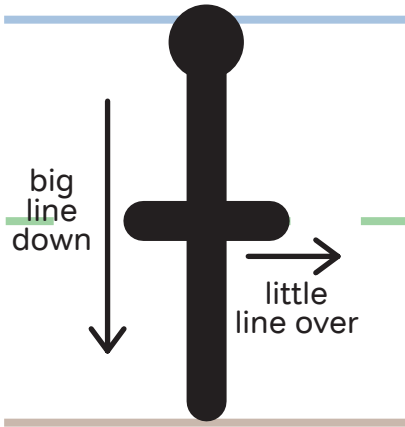

tree

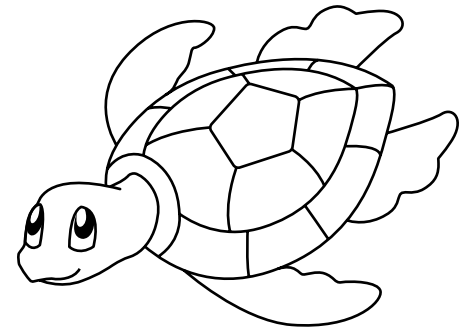

turtle

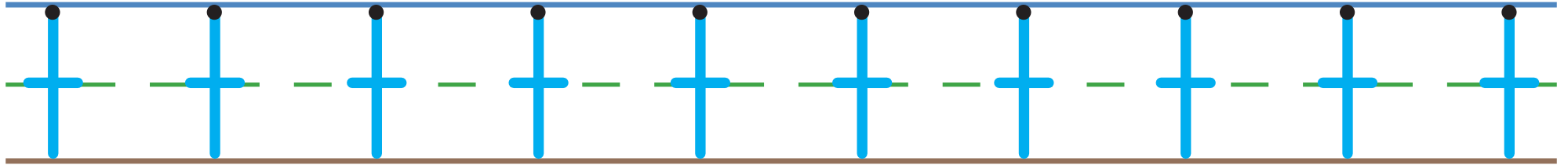

Write a lowercase letter **t** at each dot.

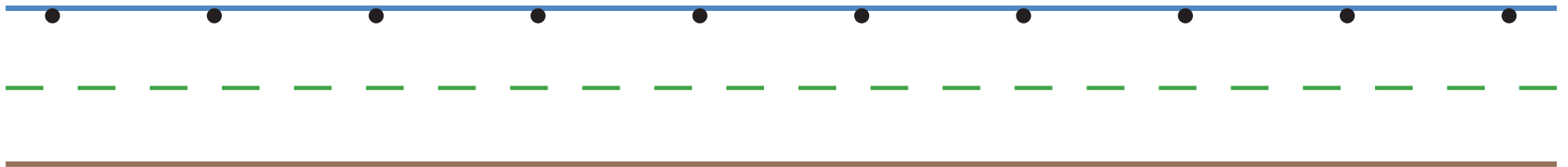

Write 10 tall **t**'s all on your own.



NAME: _____

DATE: _____

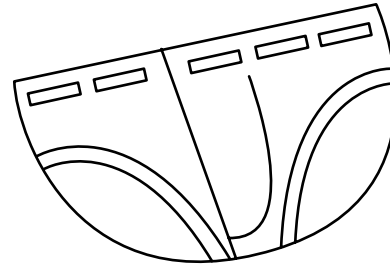
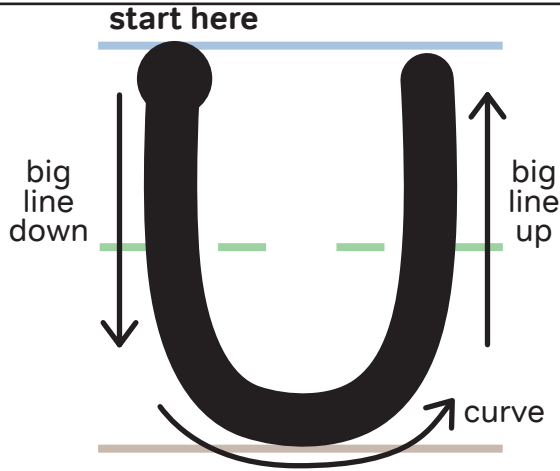

underpants



umbrella

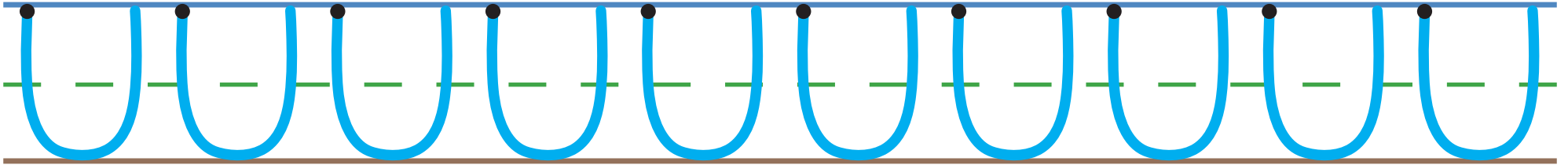

Write an uppercase letter **U** at each dot.

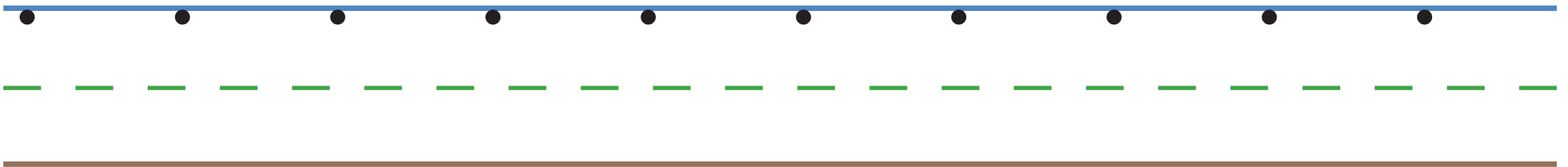

Write 10 uppity **U**'s all on your own.

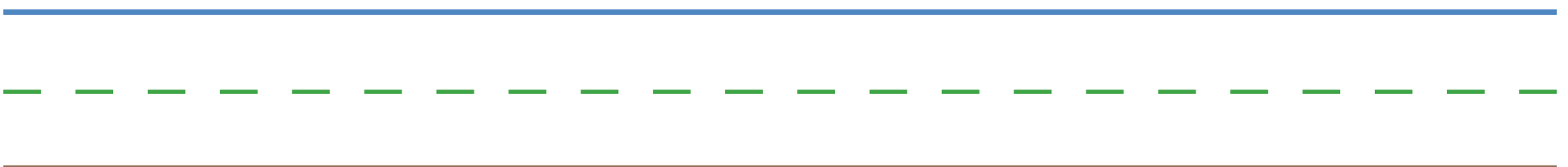

NAME: _____

DATE: _____

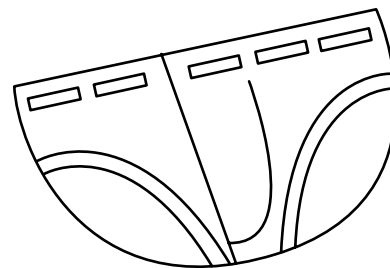
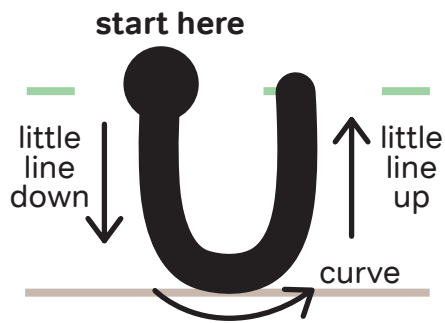

underpants



umbrella



Write a lowercase letter **u** at each dot.



Write 10 uppity **u**'s all on your own.

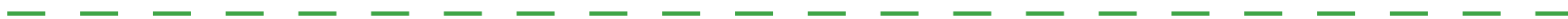

NAME: _____

DATE: _____

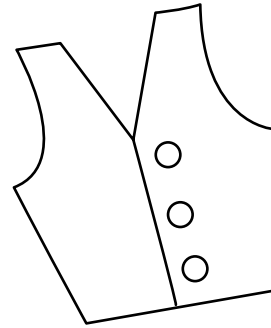
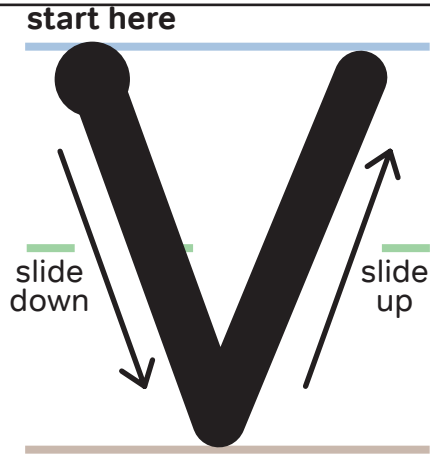

vest



violin

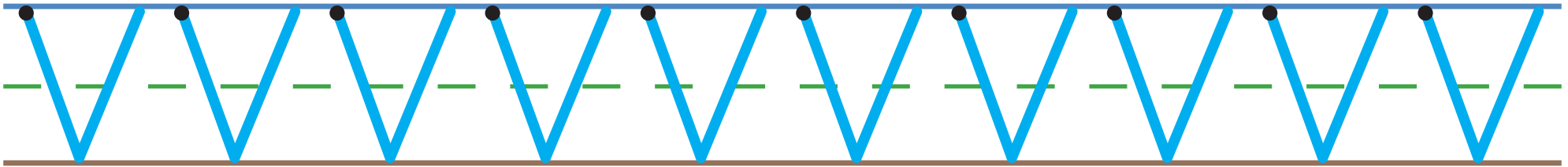

Write an uppercase letter **V** at each dot.

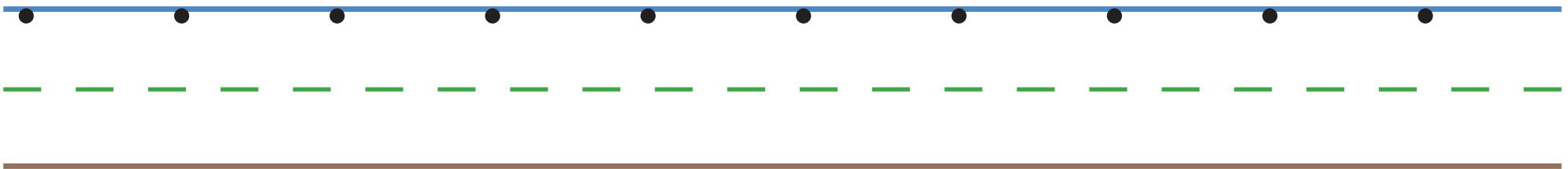

Write 10 vivid **V**'s all on your own.



NAME: _____

DATE: _____

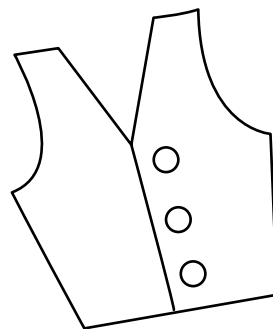
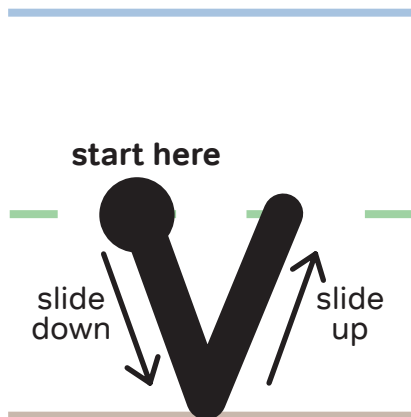

vest



violin



Write a lowercase letter v at each dot.



Write 10 vivid v's all on your own.



NAME: _____

DATE: _____

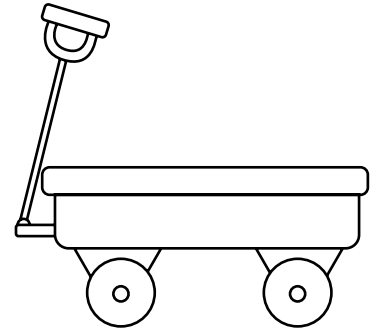
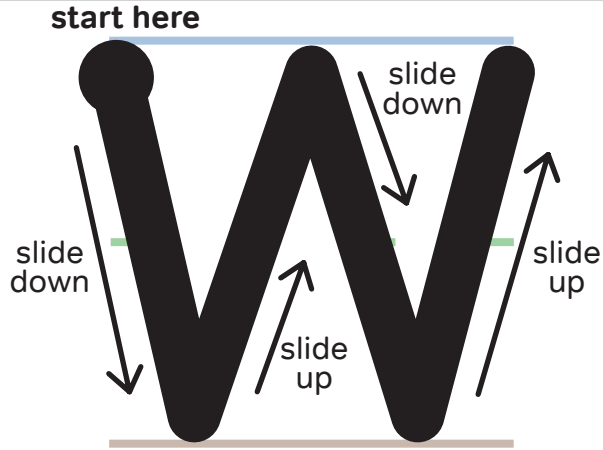

wagon

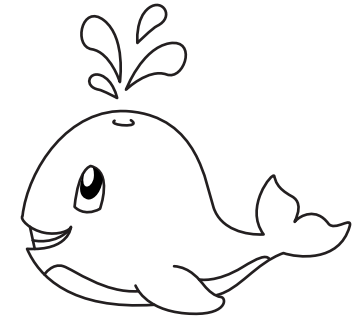

whale

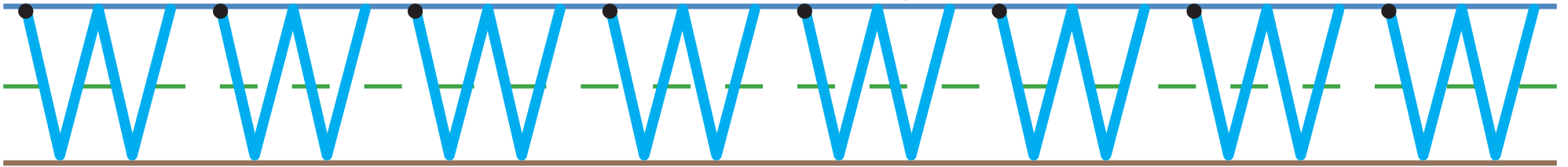

Write an uppercase letter **W** at each dot.

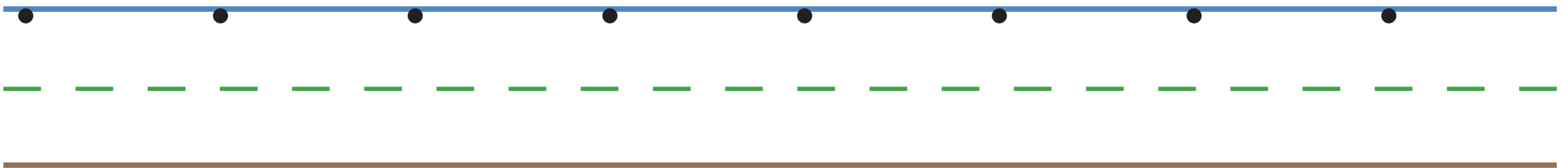

Write 10 wonderful **W**'s all on your own.



NAME: _____

DATE: _____

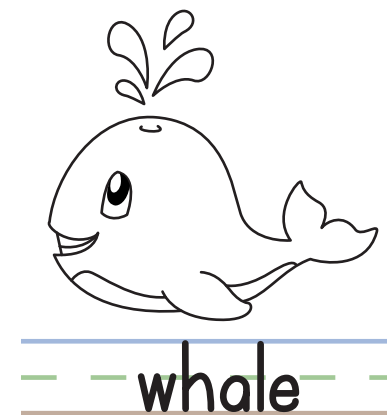
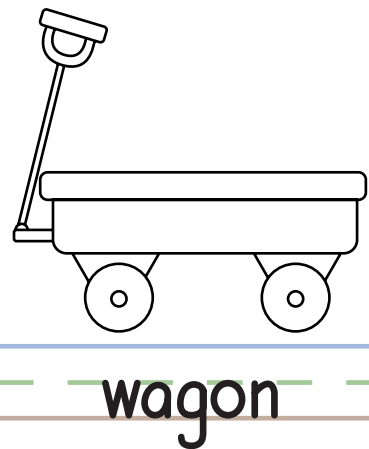
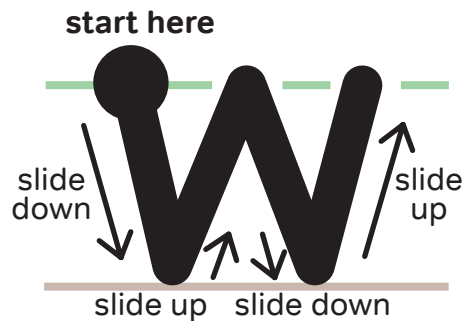

Write a lowercase letter **w** at each dot.



Write 10 wonderful **w**'s all on your own.



NAME: _____

DATE: _____

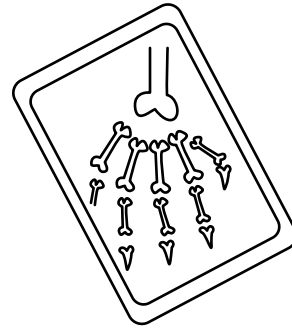
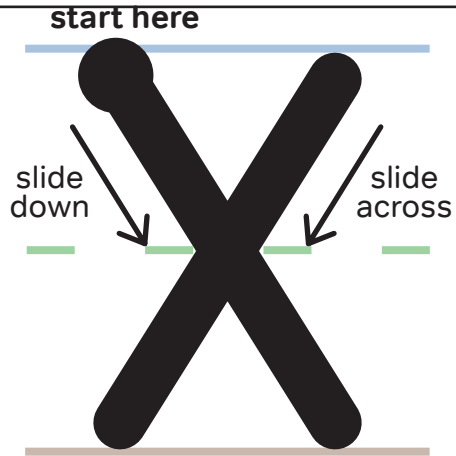

x-ray

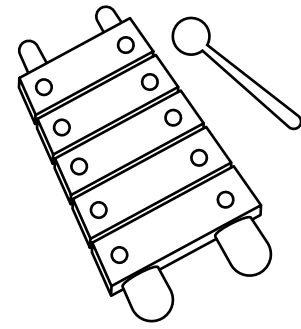

xylophone

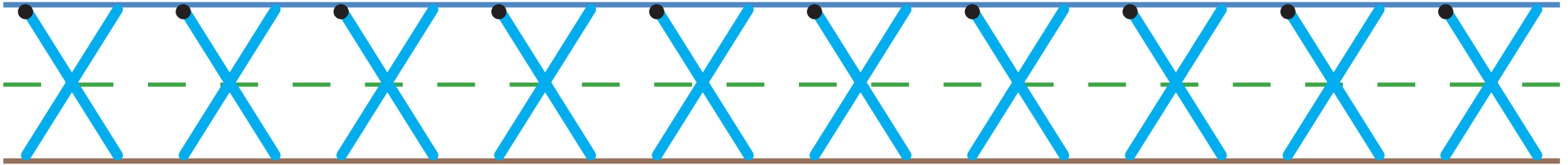

Write an uppercase letter X at each dot.

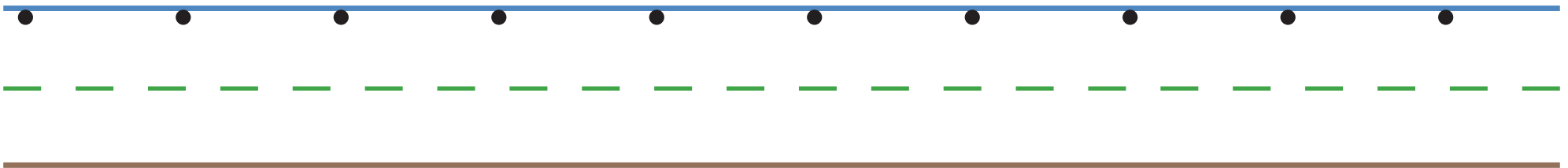

Write 10 exciting X's all on your own.



NAME: _____

DATE: _____

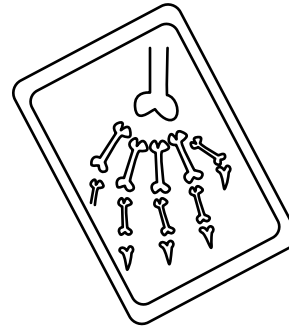
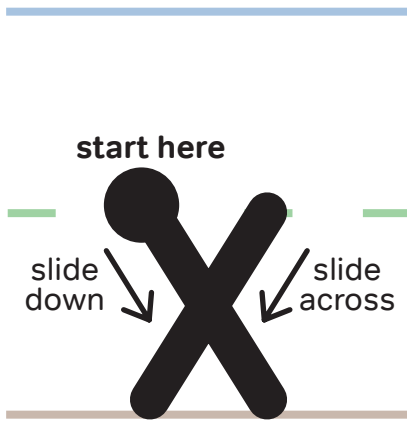

x-ray

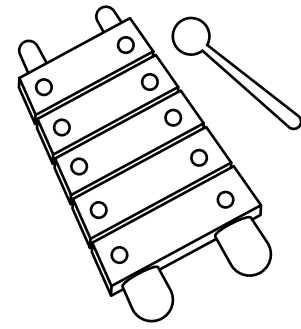

xylophone

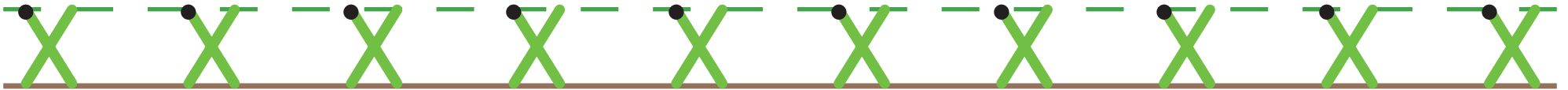

Write a lowercase letter **x** at each dot.



Write 10 exciting **x**'s all on your own.

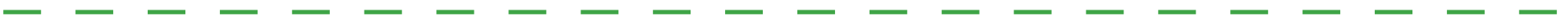

NAME: _____

DATE: _____

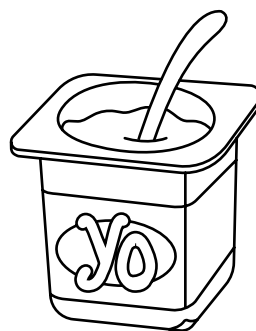
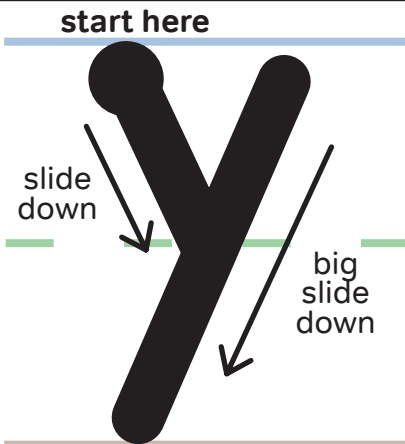

yogurt

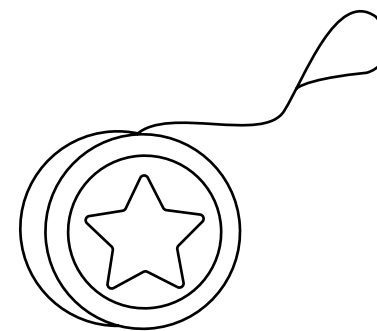

yo-yo

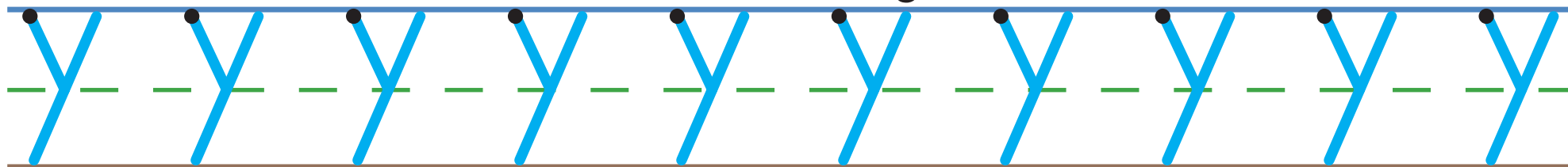

Write an uppercase letter **Y** at each dot.

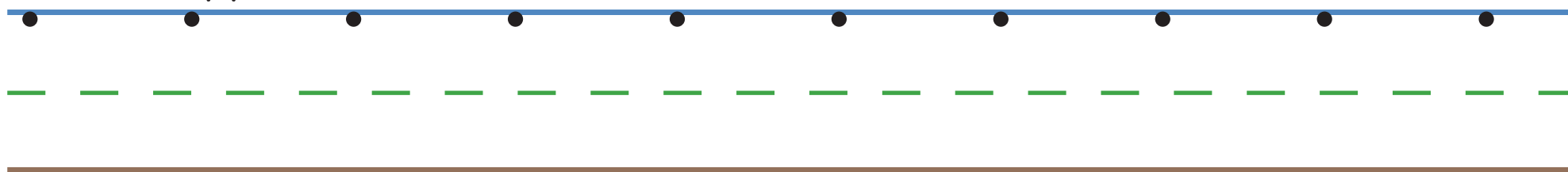

Write 10 yummy **Y**'s all on your own.



NAME: _____

DATE: _____

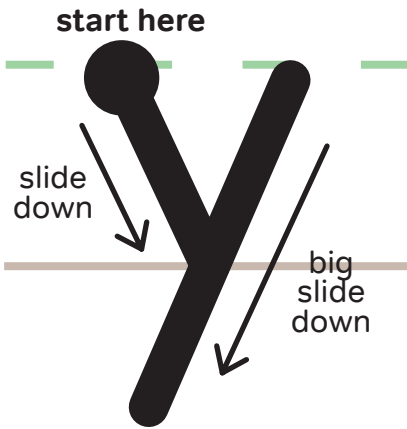

yogurt

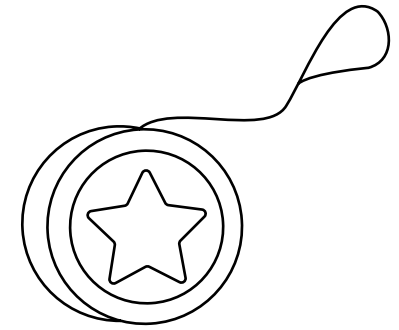

yo-yo

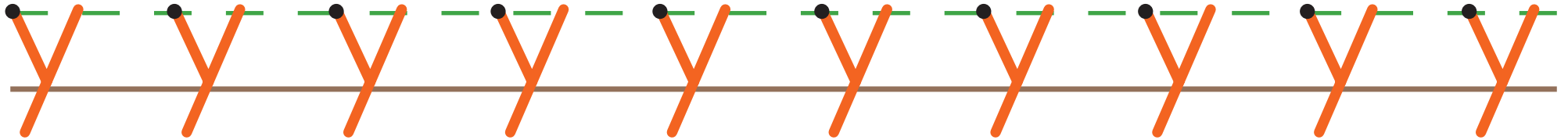

Write a lowercase letter **y** at each dot.



Write 10 yummy **y**'s all on your own.

NAME: _____

DATE: _____

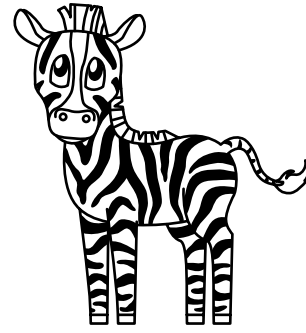
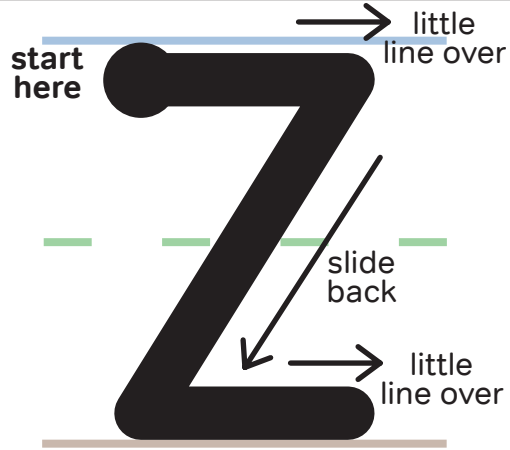

zebra

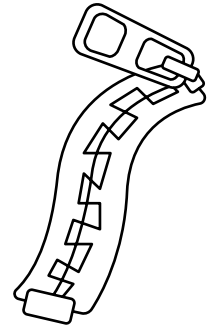

zipper

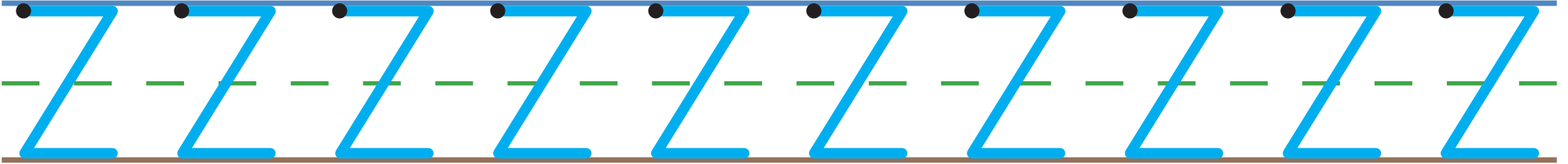

Write an uppercase letter **Z** at each dot.

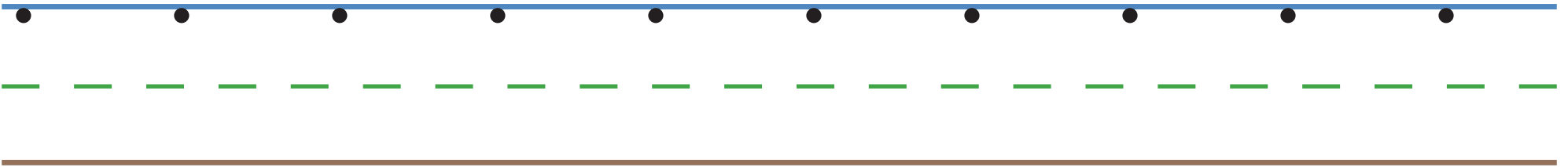

Write 10 zazzy **Z**'s all on your own.



NAME: _____

DATE: _____

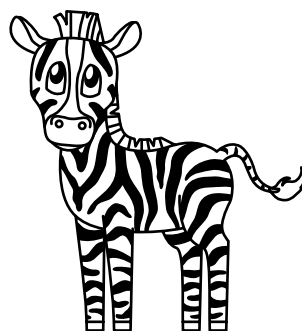
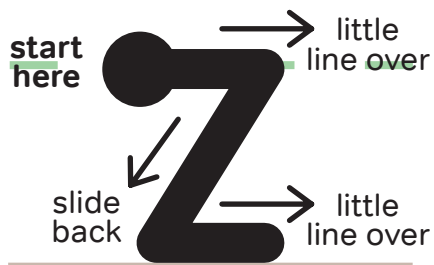

zebra

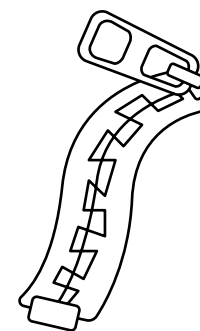

zipper



Write a lowercase letter z at each dot.



Write 10 zazzy z's all on your own.

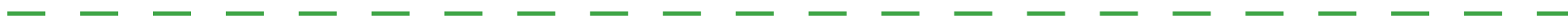

NAME: _____

DATE: _____



A

B

C

D

E

F

G

H

I

J

K

L

M

N

O

NAME: _____

DATE: _____



P Q R

S T U

V W X

Y Z

Blank handwriting lines for practice.

NAME: _____

DATE: _____



a b c

d e f

g h i

j k l

m n o

NAME: _____

DATE: _____



P

Q

r

s

t

u

v

w

x

y

z

NAME: _____

DATE: _____



Three sets of handwriting practice lines. Each set consists of a solid blue top line, a dashed green middle line, and a solid brown bottom line.

NAME: _____

DATE: _____



Handwriting practice lines consisting of four sets of horizontal lines. Each set includes a solid blue top line, a dashed green middle line, and a solid brown bottom line.